

2 -Wire Intercom System

DT591/592 User Manual

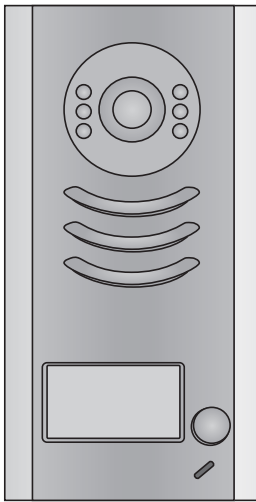

DT591

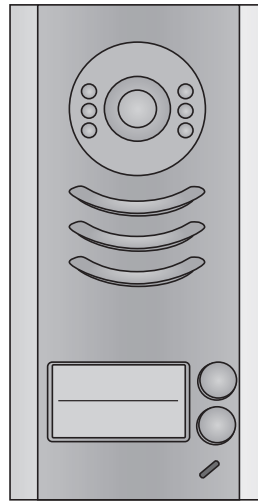

DT592

CONTENTS

1.Parts and Functions.....	1
2.Terminal Descriptions	1
3.Specifications	2
4.Mounting.....	2
4.1 Mounting Without Rainy Cover.....	2
4.2 Mounting With Rainy Cover.....	3
4.3 Placing Name Label	3
4.4 Adjusting Camera Angle	4
5.System Wiring and Connections	4
5.1 Basic Connection.....	4
5.2 Electric Lock Connection.....	5
5.2.1 Door Lock Controlled with Internal Power	5
5.2.2 Door Lock Controlled with Dry Contact	5
5.2.3 How to setup the unlock parameter in Monitor	6
5.3 Multi Doorstations Connection.....	7
5.4 Multi Monitors Connection	8
5.4.1 Basic IN-OUT Wiring Mode	8
5.4.2 With DBC-4 Wiring Mode	9
6.Setup	10
6.1 DIP Switches Settings of Doorstation.....	10
6.2 DIP Switches Settings of Monitor	10
6.3 Notices.....	12
7.Cables Requirements	13

1.Parts and Functions

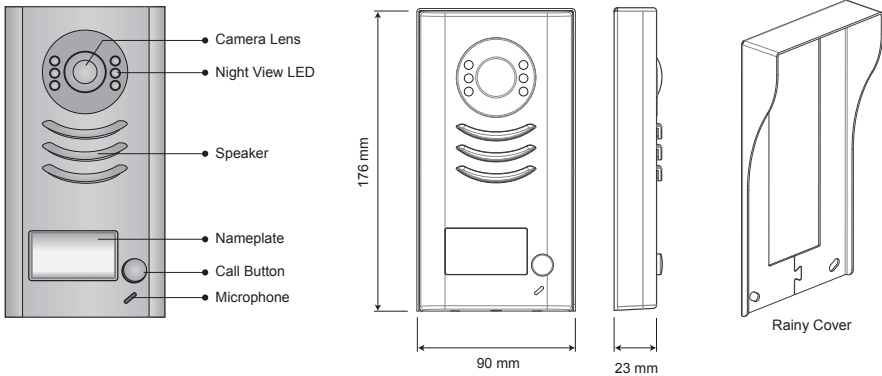

Note: DT592 has two call buttons.

2.Terminal Descriptions

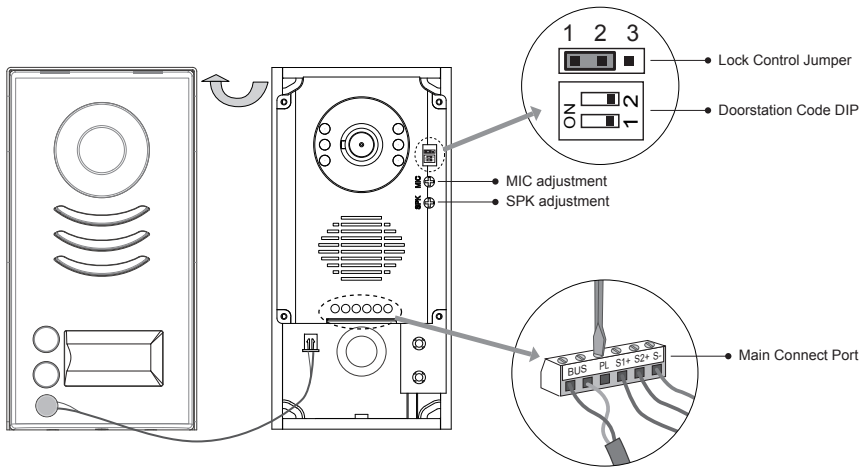

- **Lock Control Jumper:** To select the lock type: see 5.2.1 , 5.2.2
- **Doorstation Code DIP:** Total 4 doorstations can be supported,see 6.1
- **Main Connect Port:** To connect the bus line and the electronic locks.
- **BUS:** Connect to the bus line, no polarity.
- **PL:** External lock power input, connect to the power positive(power +).
- **S1+, S2+:** Lock power(+) output, to connect 2 locks.
- **S-:** Lock power(-) output, connect to the power(-) input of locks(only when using the camera to power the locks, if using the external power supply for the locks, the S- will not be connected).

3.Specifications

Lock Power supply:	12Vdc, 300mA(Internal Power)
Power Consumption:	1W in standby, 12W in working
NO, COM dry contact:	Max. 48V dc 1.5A
Unlocking time:	1 to 9 seconds, set by Monitor
Working temperature:	-10°C ~ 45°C

4.Mounting

4.1 Mounting Without Rainy Cover

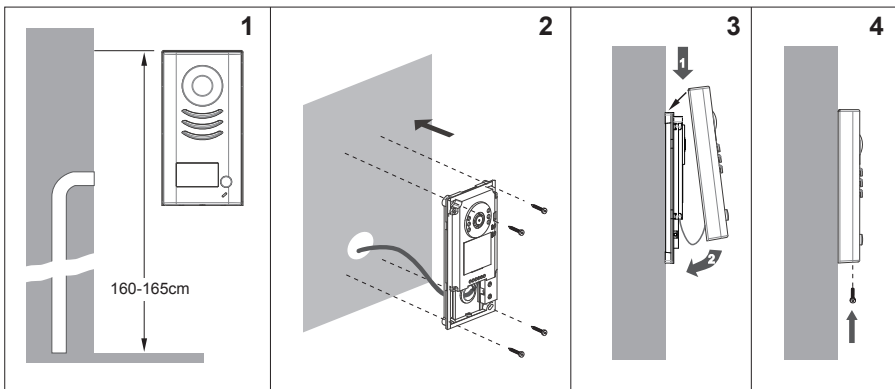

4.2 Mounting With Rainy Cover

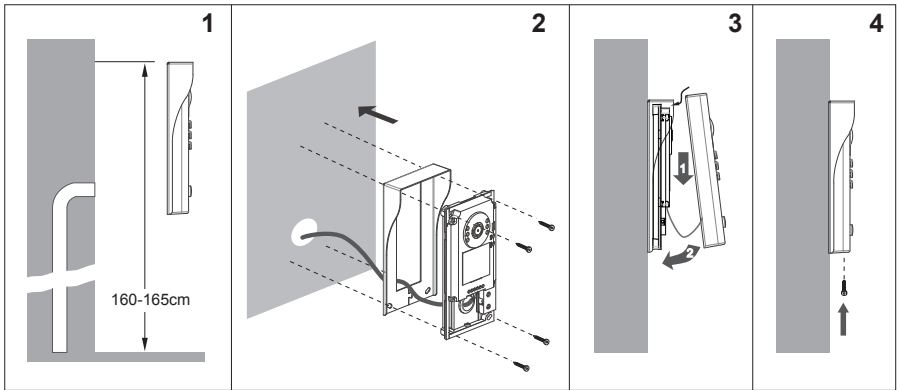

4.3 Placing Name Label

Move the plastic cover away to open the transparent name label cover, insert a name paper, then put the plastic cover back to the panel.

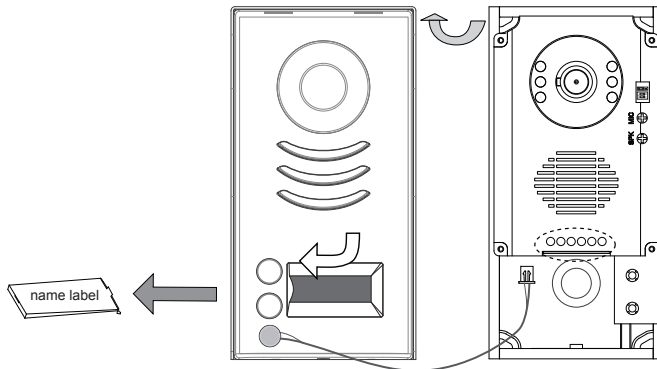

4.4 Adjusting Camera Angle

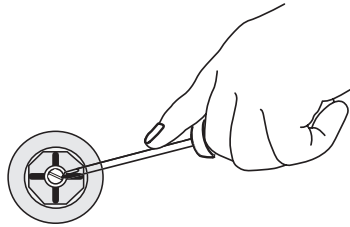
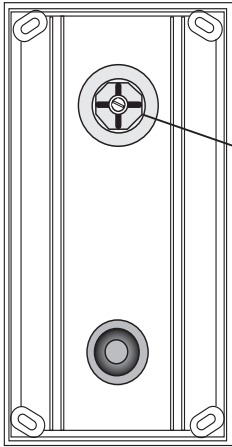

use a screwdriver to loosen the screw and then adjust the angle of the camera ,then fix the screw.

5. System Wiring and Connections

5.1 Basic Connection

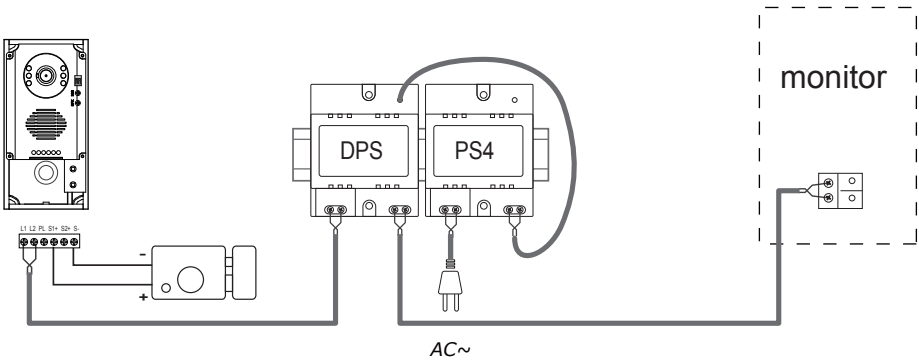

5.2 Electric Lock Connection

5.2.1 Door Lock Controlled with Internal Power

Note:

1. Electronic lock of Power-on-to-unlock type should be used.
2. The door lock is limited to 12V, and holding current must be less than 250mA.
3. The door lock control is not timed from Exit Button(EB).
4. The **Unlock Mode** Parameter of Monitor must be set to 0 (by default).

connect one lock

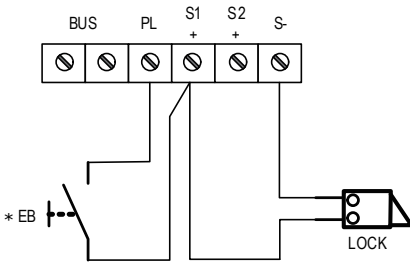
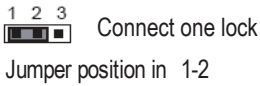

connect two locks

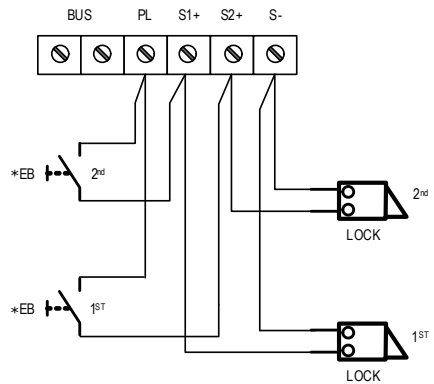
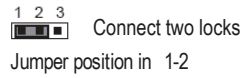

5.2.2 Door Lock Controlled with Dry Contact

Note:

1. The external power supply must be used according to the lock.
2. The jumper must be taken off before connecting.
3. Setup the **Unlock Mode** of Monitor for different lock types.
 - Power-on-to-unlock type:Unlock Mode=0 (by default)
 - Power-off-to-unlock type:Unlock Mode=1

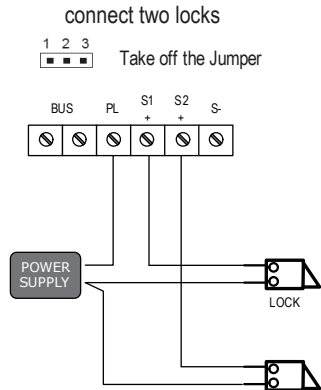
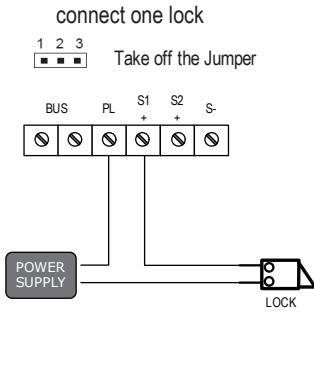

5.2.3 Unlock parameter setting(set on monitor)

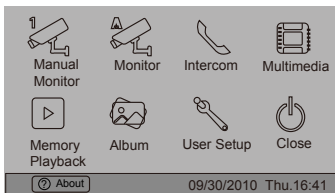

1.Touch About item on main menu page.

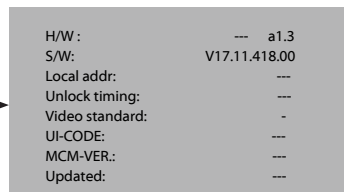

2.Touch the screen anywhere and hold for 2s.

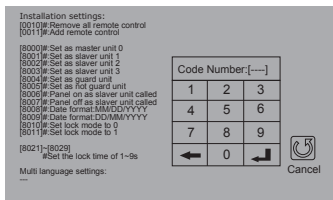

4.A digital keypad and setting instructions will be shown.

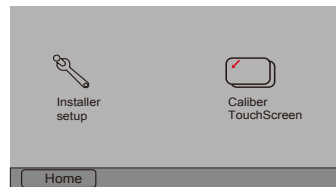

3.Touch Installer setup item

Note:

- 1.must connect DT591/592 correctly before setting.
- 2.the parameter will be saved in DT591/592 automatically,so you need only set on one monitor.
- 3.the above diagram is fit for icon menu series monitors only, to text menu series monitors,please refer to the corresponding user manual.

5.3 Multi Doorstations Connection

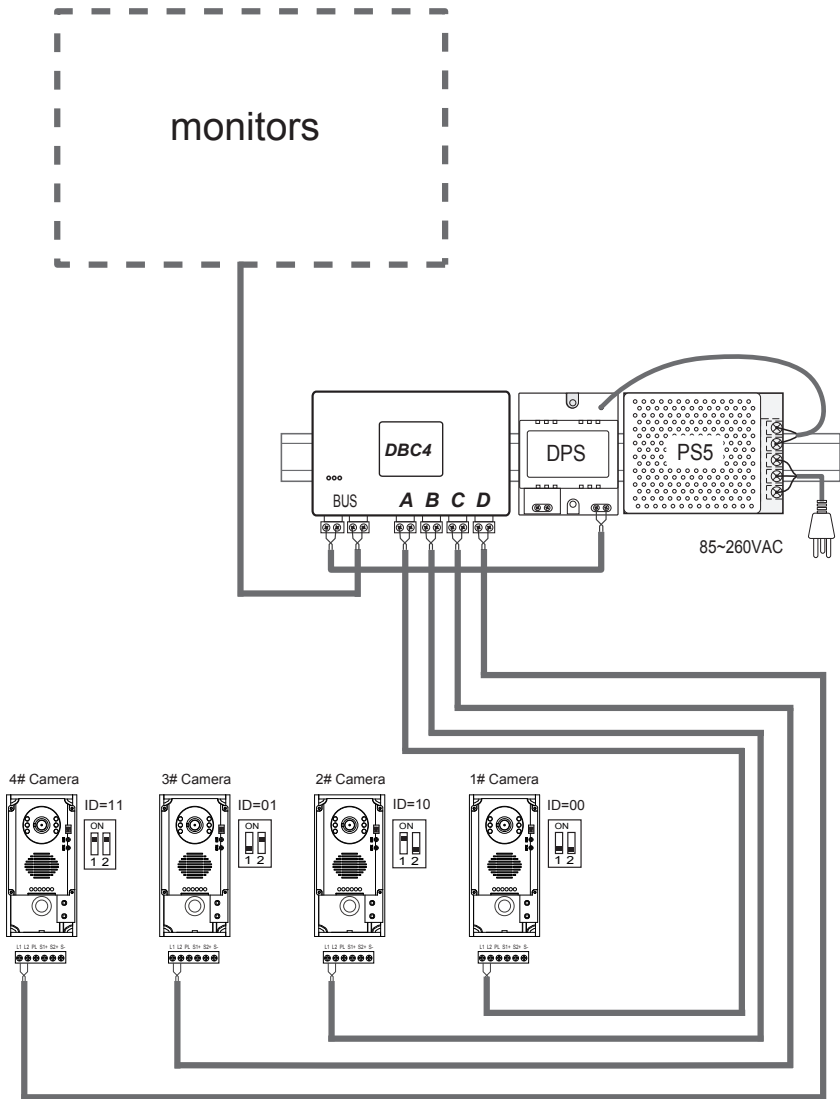

5.4 Multi Monitors Connection

5.4.1 Basic IN-OUT Wiring Mode

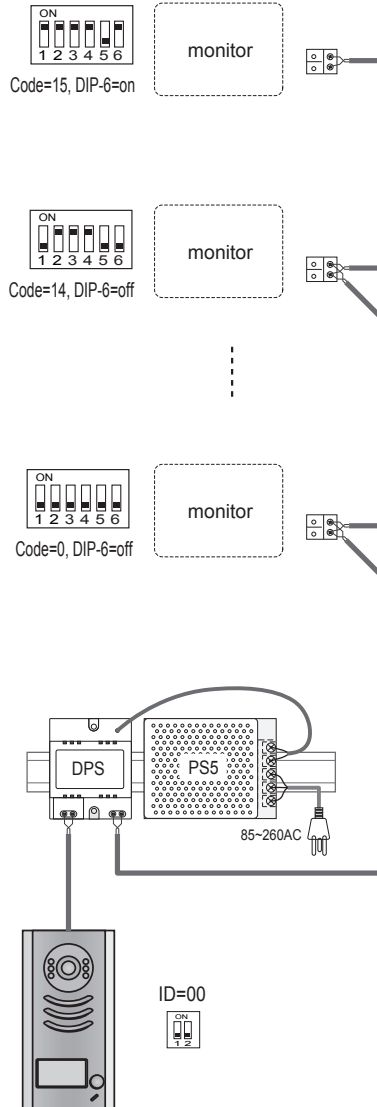

5.4.2 With DBC-4 Wiring Mode

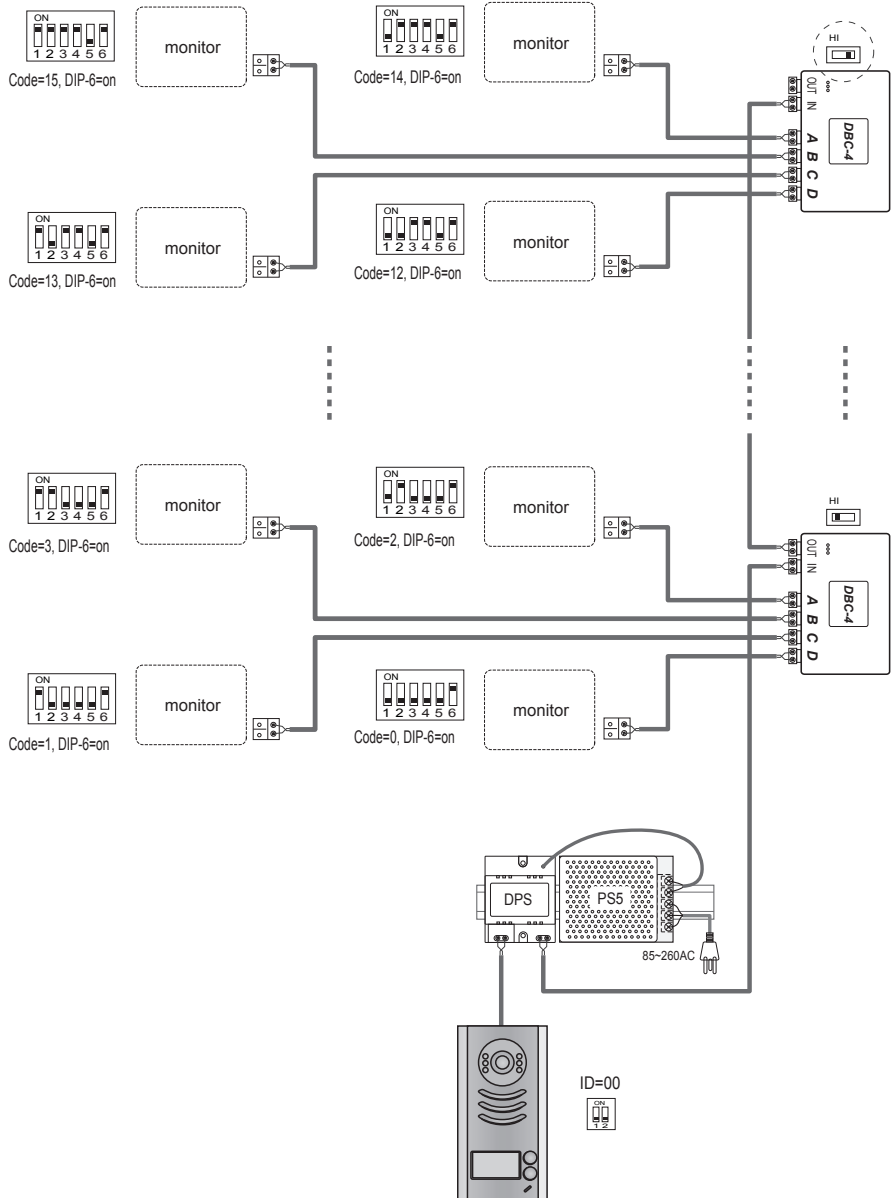



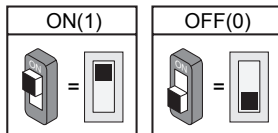

6.Setup



6.1 DIP Switches Settings of Doorstation



Total 2 bits on the DIP switches can be configured. The switches can be modified either before or after installation.

Bit state	Descriptions
	Default setting, ID = 0(00), set to the first Door Station.
	ID = 1(10), set to the second Door Station.
	ID = 2(01), set to the third Door Station.
	ID = 3(11), set to the fourth Door Station.

































6.2 DIP Switches Settings of Monitor

There are 6 bit switches in total. The DIP switches are used to configure the User Code for each Monitor.

Bit-6 is used to set video impedance, it should be set to ON if the Monitor is in the end of the line(bus), otherwise set to OFF.

Bit state	Setting	Bit state	Setting
	The monitor is not at the end of the bus.		The monitor is at the end of the bus.

Bit-1 to Bit-5 are used to User Code setting. The value is from 0 to 31, which have 32 different codes .

Bit state	User Code	Bit state	User Code	Bit state	User Code
	Code=0		Code=11		Code=22
	Code=1		Code=12		Code=23
	Code=2		Code=13		Code=24
	Code=3		Code=14		Code=25
	Code=4		Code=15		Code=26
	Code=5		Code=16		Code=27
	Code=6		Code=17		Code=28
	Code=7		Code=18		Code=29
	Code=8		Code=19		Code=30
	Code=9		Code=20		Code=31
	Code=10		Code=21		

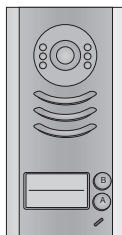

Note:Monitors response button A must set the user code from 0 to 15.and button B set the user code from 16 to 31.

6.3 Notices

Name	Description	Usage
PS5-24V	Power supply,85~260Vac input,24Vdc/3A output,10 DIN modules	Connect with multi doorstations or multi monitors(up to 2 or above)
PS4-24V	Power supply,85~260Vac input,24Vdc/1A output,for basic kit only,4 DIN modules	Connect with one doorstation and one monitor(DT16 can be connected two)

7.Cables Requirements

The maximum distance of the wiring is limited in the DT system. Using different cables may also affect the maximum distance which the system can reach.

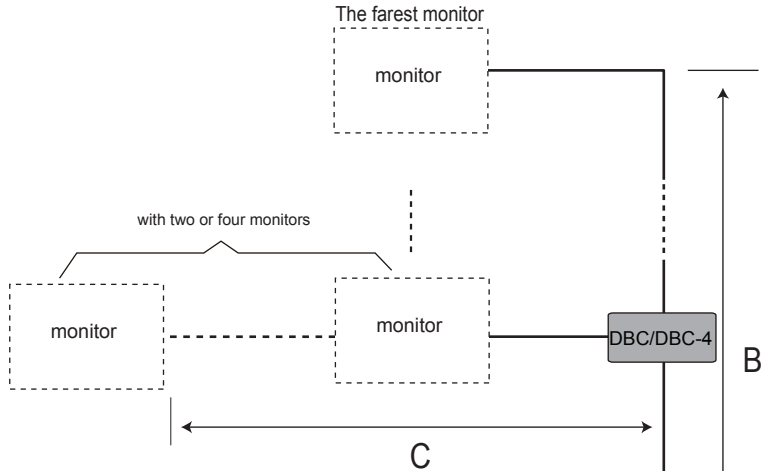

When Monitor quantity < 20

Cable Usage	A	B	C
Twisted cable 2x0.75 mm ²	60	60	30
Twisted cable 2x1 mm ²	80	80	40

When Monitor quantity > 20

Cable Usage	A	B	C
Twisted cable 2x1 mm ²	70	30	20
Twisted cable 2x1.5 mm ²	70	50	30

Note:If the monitor has been specified the distance,refer to the parameter.

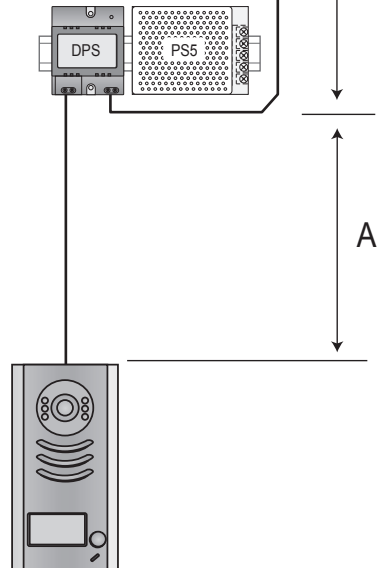



The design and specifications can be changed without notice to the user. Right to interpret and copyright of this manual are preserved.
