

2 WIRE SYSTEM

DT47MG(V2)-TD7

7" VIDEO HANDS-FREE COLOR TFT MONITOR

USER MANUAL

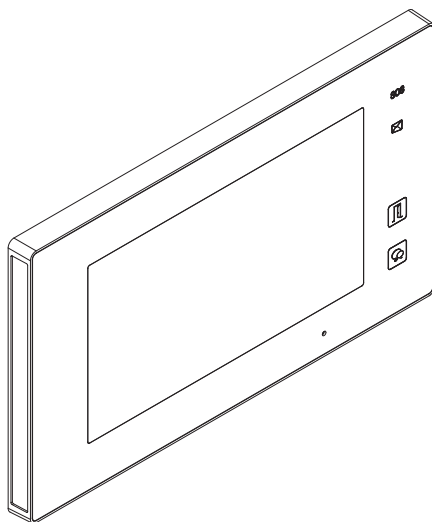

- Please read this manual carefully before using the product you purchase, and keep it well for future use.
- Please note that images and sketch maps in this manual may be different from the actual product.

PRECAUTIONS

- Slots or openings in the back of the monitor, are provided for ventilation and to ensure reliable operation of the video monitor or equipment and to protect it from overheating. These openings must not be blocked or covered. The monitor should never be placed near or over a radiator or heat register and should not be placed in a built-in installation such as a bookcase unless proper ventilation is provided.
- All parts should be protected from violence vibration. And not allow be impacting, knocking and dropping.
- For clean the LCD screen, using hands or wet cloth is forbidden.
- Please do the cleanness with soft cotton cloth, please do not use the organic or chemical detergent. If necessary, please use pure water or dilute soap water to clean the dust.
- Image distortion may occur if the video door phone is mounted too close to magnetic field e. g. Microwaves, TV, computer etc.
- Please keep away the video door monitor from wet, high temperature, dust, and caustic and oxidation gas in order to avoid any unpredictable damage.
- Do not open the device in any condition, call the administrator for help if there is any problem.

CONTENTS

PARTS AND FUNCTIONS	4
Front panel	4
Mounting.....	5
Screen	6
BASIC OPERATIONS	7
Answering a call	7
Pan-tilt & Zoom.....	9
Adjusting screen&volume	10
Door release	11
Calling other monitors.....	11
Monitoring.....	12
Recording	13
Viewing images/videos	14
Formating SD card	15
Copying recordings to SD card.....	15
Leaving messages.....	16
Viewing visitor messages	16
Mute function	17
Transferring call.....	18
Setting divert number	19
Viewing calling records.....	19
SMS function	20
Opening staircase light	21
Motion detect function	22
SETUP INSTRUCTIONS	23
Setting date and time.....	23
Setting ring tone	23
Setting ring volume.....	24
Enabling/Disabling the operation sound	24
Naming door station & camera	24
Setting monitor time.....	25
Enabling/Disabling motion detect function	26
Enabling/Disabling intercom function	26
Changing the display language	27
Restoring to default setting.....	27
SYSTEM CONFIGURATIONS	28
Entering installer setup.....	28

PARTS AND FUNCTIONS

Front panel

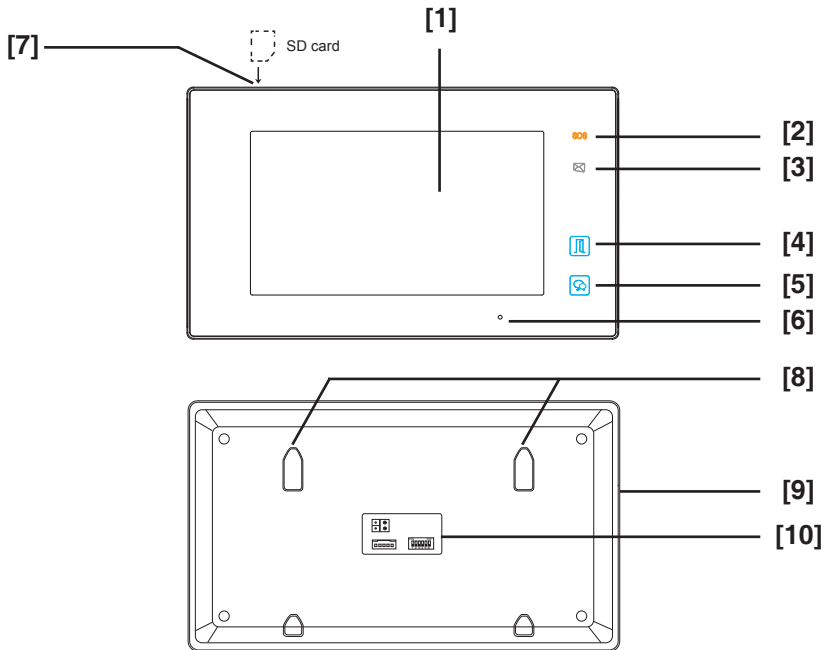

Key functions

NO.	Item	Description
[1]	Digital LCD touch screen	<ul style="list-style-type: none"> • See the next page for details • Display the visitors' image
[2]	Emergency button	Press it & hold for 3s to send SOS message to mobile phone, the function is supported by GSM unit.
[3]	Message indicator	Light up when the monitor has missed call
[4]	Unlock button	Press to release the door
[5]	Talk/Mon button	<ul style="list-style-type: none"> • Press to communicate hands free with visitor • Press to view the outdoor condition in standby mode
[6]	Microphone	Transmit audio from one station to other stations
[7]	SD card slot	Use to insert micro-SD card
[8]	Mounting hook	Use to hang up the monitor
[9]	Speaker	Send out sounds of ring tones, audios and alarms
[10]	Connection port	Bus terminal

PARTS AND FUNCTIONS

Mounting

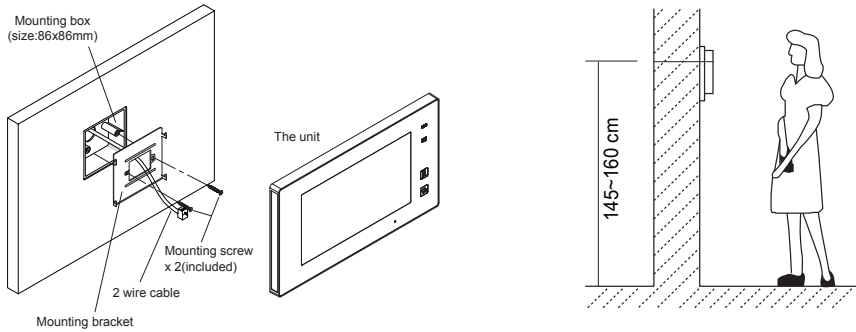

The installation height is suggested to 145~160cm.

1. Use screws to fasten the mounting bracket to the wall with mounting box.
2. Connect the 2 wire cables to the unit.
3. Mount the unit to the mounting bracket, make sure the unit is absolutely attached to the mounting bracket.

Terminal description

L1,L2: Bus line terminal.

SW+,SW-: Extra door bell call button connection port.

Ring,GND: Extra buzzer connection port.

NC: Undefined.

DIP switches: Total 6 bits can be configured.

- **Bit1~Bit5:** User Code setting.
- **Bit6:** Set to **ON** if the monitor is at the end of the line or works with DBC4A. Otherwise, set to **OFF**.

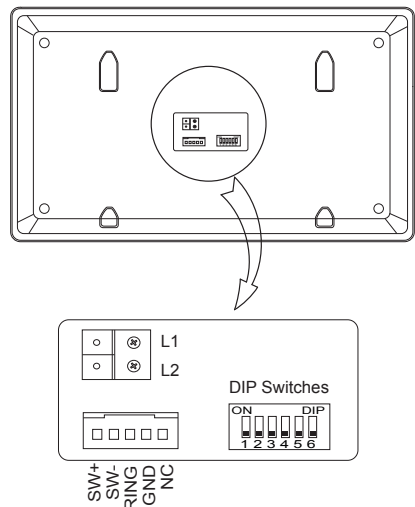

PARTS AND FUNCTIONS

Screen

Main Menu

The Main menu is your starting point for using all the applications on your monitor. You can customize your Main menu to display your logo.

Touch anywhere of the screen on monitor in standby mode, the Main menu will appear as follow:

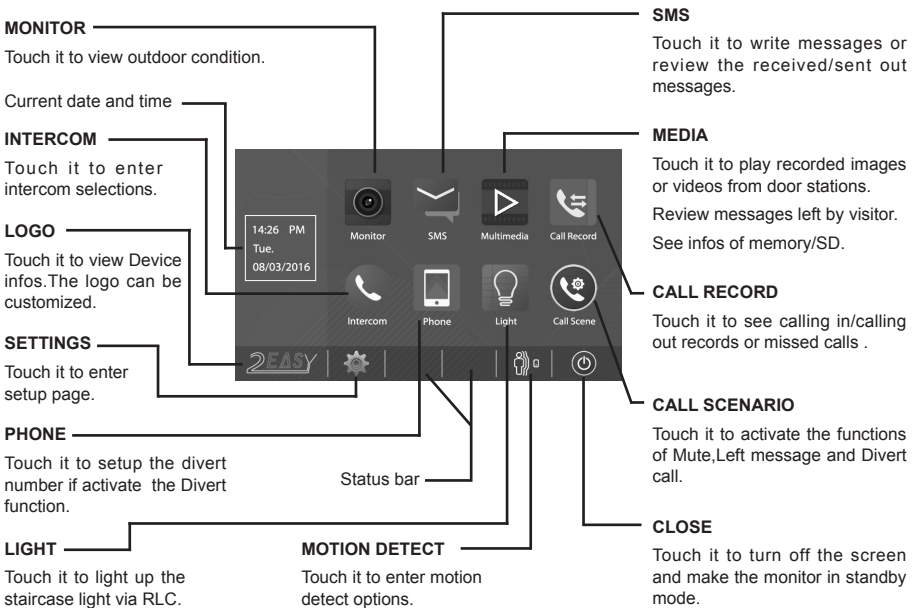

While talking with a door station

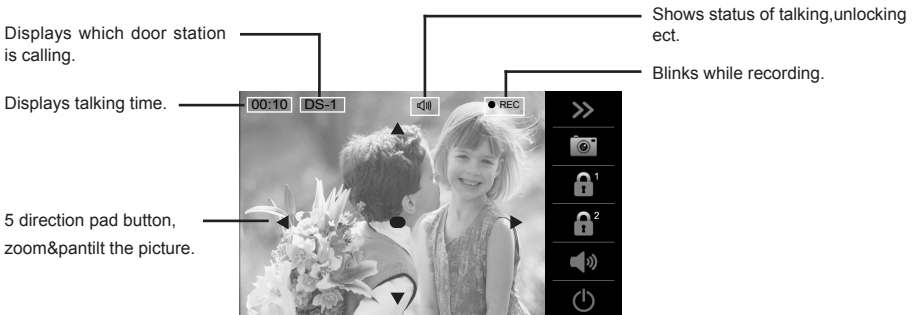



Note: The 5 direction pad operation should make effective with **fish-eye** door station.

BASIC OPERATIONS

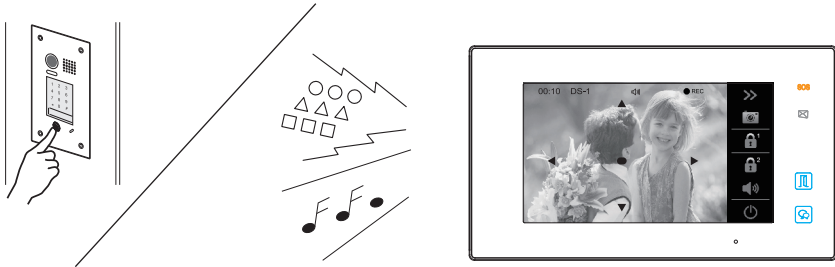
Answering a call



- When there is a call from a video door station. The call tone sounds, an image will be displayed on the screen.
- Touch  icon on screen or press  **TALK/MON** button on the panel, begin communicating hands free with the visitor for 90 seconds.
- While communicating with the visitor, unlock the door, capture images/videos and adjust screen & volume are available. More details, please refer to the following descriptions.

Note: 1. If nobody answers the phone, the screen will be turned off automatically after 40 seconds.

2. The 5 direction pad operation should be effective with **fish-eye** door station.

Monitoring cameras while being called/talking

It's available to select cameras to monitor while being called.

Max. 16 cameras can be selected to monitor, 4 cameras is default.

Follow the steps:

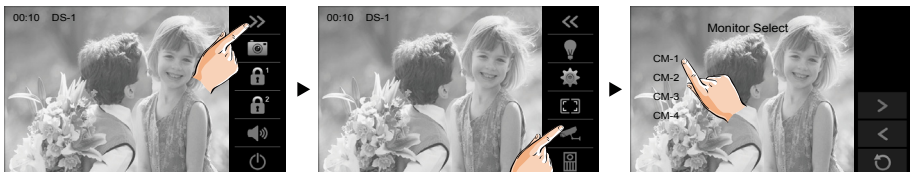

BASIC OPERATIONS

Adjusting image scale while being called/talking

It's available to adjust image scale while being called. Total 3 image modes can be selected.

Follow the steps:



Compare the difference of these 3 image modes:

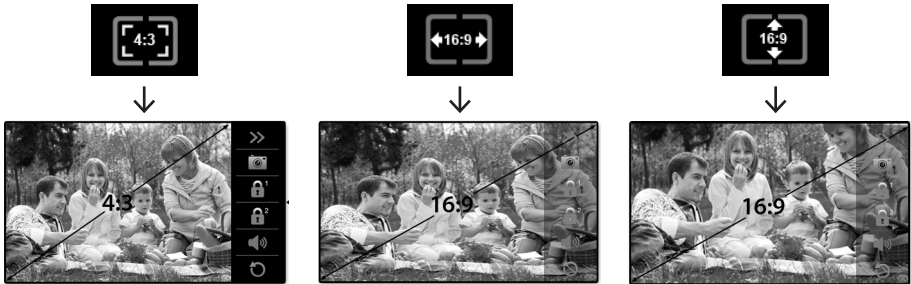

To complete communication

- Touch  icon on screen or press the  TALK/MON button on the panel to complete the communication.

Note: Communication also ends automatically after 90 seconds.

1.Receiving a call while talking with a door station

- Other door stations calling is forbidden
- Conclude current talking to answer the new call-in

2.Receiving a call while talking with other monitors

- The talking will stop immediately, call tone sounds in normal.
- The video image from the door station is displayed on the screen, talking,unlock,capture images/videos, adjust screen&volume are available.

BASIC OPERATIONS

Pan-tilt & Zoom

It is available to adjust the display mode for viewing images at a **fish-eye** door station by using the 5 direction pad button.

When an image at a door station is displayed, move to the desired position by touching ▲ ▼ ● ◀ ▶ on the screen to view the image in zoom mode.

Note:

- 1.The zoom&pantilt function should make effective with fish eye door station.
- 2.The edge of pantilt image will not be displayed.

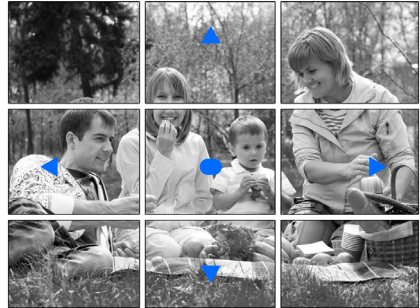

Here are some examples:

- Touch ● icon to zoom the center position.



- Touch ▶ icon to zoom the right position.

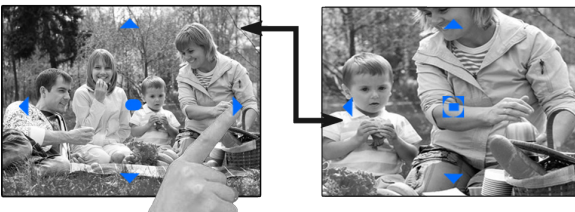

BASIC OPERATIONS

Adjusting screen&volume

While receiving a call from door station, or monitoring /communicating with the visitor,you can adjust the screen and speaker volume. Follow the steps:



Adjusting images

Total 4 scene modes can be selected in sequence:**Normal, Brightly, Soft and User**.Whichever mode you choose, there will be a corresponding value for contrast,brightness and color.

You should know that the contrast,brightness and color can be modified freely, but this action should be at the **User** scene mode.



Adjust the contrast of the screen,the range is 0~9. Touch - or + to change the level.



Adjust the brightness of the screen ,the range is 0~9. Touch - or + to change the level.



Adjust the color of the screen,the range is 0~9. Touch - or + to change the level.

Note: The adjustments have no effect on the recorded images.

Adjusting the speaker volume

Volume can be adjusted at any time.

Adjusting range: 0 (mute), 1 - 9.



Touch - or + to reach desired level.

BASIC OPERATIONS

Door release

It is available to release the door during a call-in, communication, or while monitoring a door station.

Touch either  or  icon on the screen or press  **UNLOCK** button on panel to release door. The door lock is released for the set door release time.

(if two locks are connected to door station, touch  icon to release the second lock.)

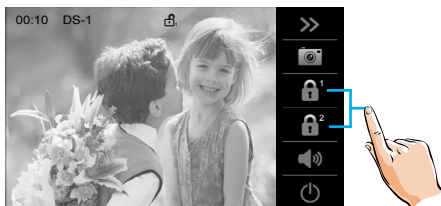

Calling other monitors

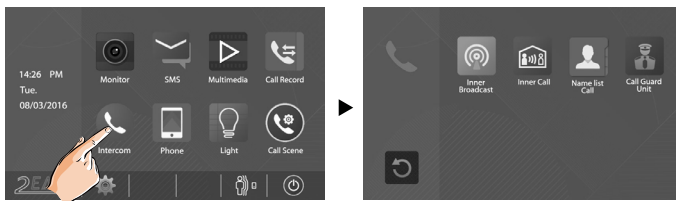

It is available to call between monitors in the same room or in the same system, or call the Guard Monitor. Follow the steps to activate the functions:



Calling monitors in the same room

1. Touch **[Inner Broadcast]** icon on one of monitor, all other monitors in the same room can automatically receive messages without answering the call. Note that all other monitors will not open the screens.

2. Touch **[Inner Call]** icon on one of monitor, all other monitors in the same room will ring at the same time, whichever monitor answers the call, conversation is started, other monitors will stop ringing at once. (Calling ends automatically after 30 seconds if nobody answers the call)

* Use "" or "" to adjust the microphone volume.

* Touch  icon to end the calling.

BASIC OPERATIONS

Calling other monitors in the same system

Touch **[Name list Call]** icon on monitor, the users in the same system will be displayed. Just select one target, touch  icon to call the corresponding user. If the call is answered, conversation is activated.

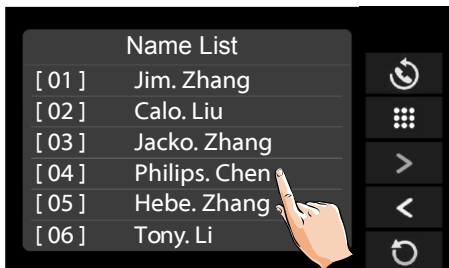

Note:

- * Use "<" or ">" to scroll pages.
- * Touch "⋮" to rename.
- * Touch " " to redial when the icon is on the screen.
- * Calling ends automatically after 30 seconds if nobody answers the call.

Calling the guard monitor

A Monitor can be assigned as Guard Unit Monitor; when the Guard Unit Monitor answers the call, conversation with the guard person is started..

Monitoring

You can monitor the entrance at any time via the monitor.

- 1.Touch anywhere of the screen on monitor in standby mode.
- 2.Touch **[MONITOR]** icon on main menu page to enter **Monitor select** page.

*Note: Press  TALK/MON button on panel in standby mode to monitor the master door station in shortcut.

Monitoring door stations/cameras:

- DS1~4 and CAM1~4 can be selected to monitor individually if the system installs multi door stations/cameras. See the following steps:

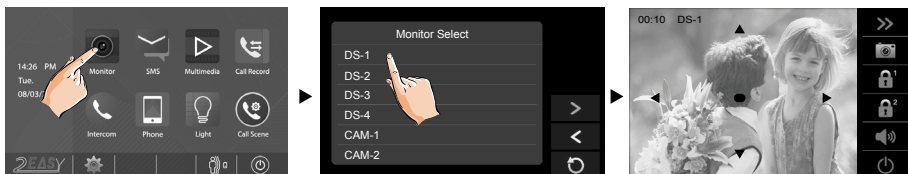

* During monitoring, images can be viewed, but audio cannot be heard.

* If there is a visitor at the entrance, touch  icon on screen to begin communication with door station.

BASIC OPERATIONS

Video Quad Monitoring:

If the system installs multi cameras via QSW. **Video quad monitoring** is available.

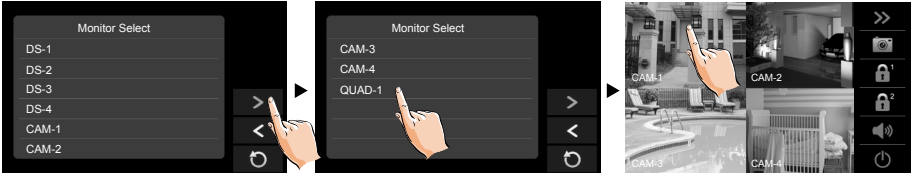

- On **Monitor select** page, touch “>” icon to scroll next page.
- Select “**QUAD-1**” item to activate video quad monitoring, see the following steps:



* During monitoring, manual recording is available.

* Touch each one of video to switch to monitor the corresponding camera Independently.

3.To end monitoring

Touch  icon on the screen or press  **TALK/MON** button on panel.

* Monitoring also ends automatically after 30 seconds.

Available functions during monitoring(not including video quad monitoring)

- Pantilt & zoom
- Adjusting images(image scale/bright/color/contrast)
- Door release
- Volume control
- Manual recording

Recording

Videos and images are possible to be recorded, both automatic recording and manual recording are available.

Automatic recording

- Recording starts after 3 seconds while receiving a call.
- While recording, “● REC” blinks on the screen.
- Capture one picture automatically for each calling.



BASIC OPERATIONS

The recorded images are stored in the built-in memory first.

- * Max. 118 pictures can be stored in inner memory
- * If a micro-SD card is installed, images can be copied to SD card.
- * Max. 32G Micro SD card is supported.

Note:

- * Automatic recording function cannot be cancelled.
- * Automatic recording is not available while monitoring a door station. To save images while monitoring, see manual recording below.

Manual recording

While being called, Touch  icon when an image is displayed.

Note:

- * Manual recording is available at any time when  icon is on the screen.
- * Manual recording is allowed in pantilt & zoom mode.
- * Manual recording cannot be performed during automatic recording.

- * If the monitor installed a micro SD card, the recording format is video, and recording time limited is 10s. The videos will be saved on micro SD card directly. Otherwise, the recording format is image.
- * A brand new SD card needs to be formatted by the monitor, then it can be used for video & audio recording.

Viewing images/videos

The recorded images/videos can be playback on monitor. Follow the steps:

- On main menu page, touch **[Media]->[Graphics Playback]** icon, most recent recordings are displayed (If insert a micro SD card, playback videos. Otherwise, playback images).
- Touch " < " or " > " to scroll through recordings, touch " " to delete current image/video (Please note that if the recordings are videos, touch " || " icon to start/pause the videos).

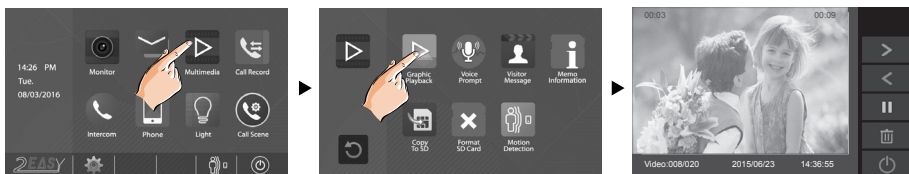

To stop

Touch  icon on the screen during play.

BASIC OPERATIONS

Formatting a SD card

Micro-SD cards need to be formatted when using them in this monitor for the first time.

- * When formatting a micro-SD card, all existing data on card is erased.
- * To **EXPORT RECORDED IMAGES**, refer to following item on this page.
- * To **VIEW SD CARD INFO**, on main menu page, touch **Multimedia->Memo information**.

1. On main menu page, touch **Multimedia->Format SD Card**. A notice message is displayed.
2. Touch icon to continue formatting. Touch icon to cancel formatting.

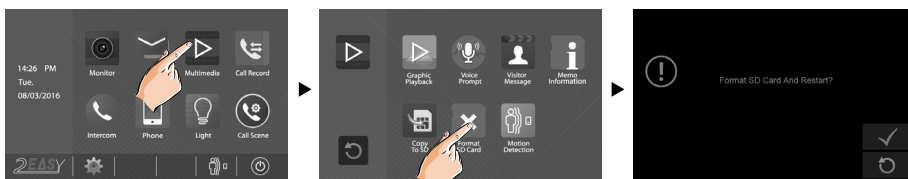

- * When a sound beep beep is sent out and a blue screen is displayed, formatting is complete.
- * It may take some time until formatting has been complete.

Copying recordings to SD card

You can copy recordings(videos/images) stored in the built-in memory to a SD card.

- On main menu page, touch **[Media]->[Copy to SD]**, the information of "Copy Pictures To SD?" will be asked.
- Touch icon to copy. Touch icon to cancel.

When copying is completed, "BKUP_PIC" folder is created on the Micro SD card. Copied images are stored with the following file names:

20151119_115125.jpg

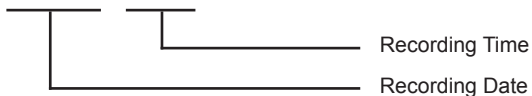

Note:

- * This action will overwrite all existing images in the "BKUP_PIC" folder on the micro SD card.
- * If the number of images or folders exceed the limit of micro SD card, they cannot be copied.
- * The images on the micro SD card cannot be copied into the built-in memory.
- * If copied is fail, try to format the SD card on the monitor.

BASIC OPERATIONS

Leaving messages

This function is very useful when you are away home. Must insert a micro SD card to support this function.

To activate the function, please follow the steps:

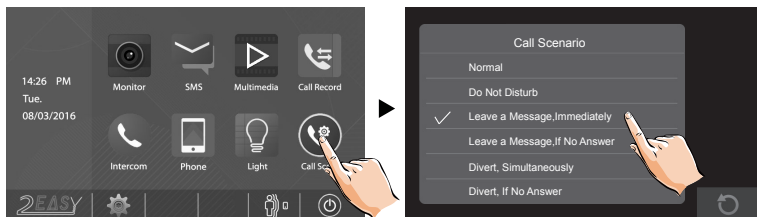

Two modes can be selected.

Leave a Message, Immediately: If you select this mode, when receiving calls from door station, The system will prompt visitor to leave a voice message immediately.

Leave a Message, If No Answer: If you select this mode, door station calls indoor monitor first, if nobody answers the call within 30 seconds, the system will prompt visitor to leave a voice message.

Note:

- * The time limited for leaving message is 10s.
- * The status bar on main menu page will show "OO" icon.
- * Touch  icon on the screen to exit.

Viewing visitor messages

All visitor messages from door stations will be recorded and can be reviewed afterwards. To support this function, the **Call Scenario** mode should be set to "Leave a Message, Immediately" or "Leave a Message, If No Answer". Please refer to the above in detail.

On main menu page, touch **[Multimedia]**->**[Visitor Message]** icon, the most recent visitor's messages are displayed.

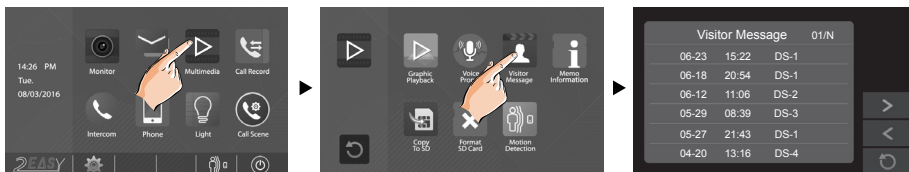

BASIC OPERATIONS

You can review who is visiting at some time.

1. Touch one of the visiting list.
2. Touch  icon to show the caller's image.

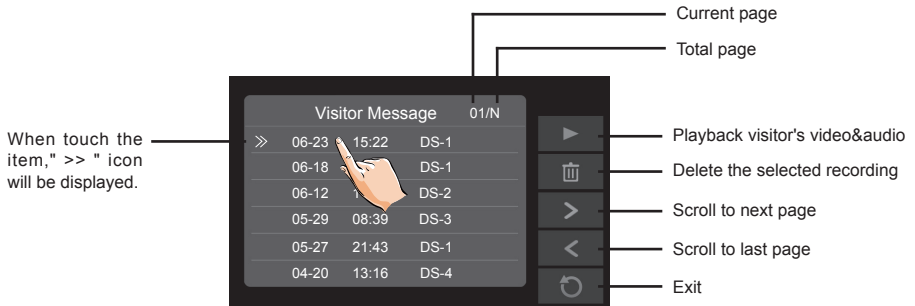

Note:

- * Max. 100 messages can be displayed.
- * Must insert a SD card to support this function.

Mute function

If you don't want to be disturbed,for example,at night. Activating the mute function is necessary for you.Follow the steps:

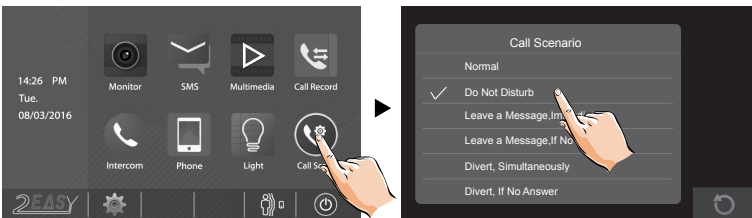

Do Not Disturb: If you select this mode, calling from door station or other monitors can not be made effect.

Note:

- * This function will perform immediately if selected,and the status bar on main menu page will show "🔇x" icon.
- * Touch  icon on the screen to exit.

BASIC OPERATIONS

Transferring call

The calling from door station can be diverted to your phone. please note that this function should be supported by the unit of TPC/GSM/TPS. Follow the steps to activate this function:



Two modes can be selected.

1. Divert, Simultaneously: When receives call from door station, diverts the call to the phone immediately.

At this mode, the monitor will always open the screen and show image from door station during diverted, if the monitor answers the call at this time, diverted will conclude at once.

Available functions during transferring at this mode:

- Pantilt & zoom
- Adjusting images(image scale/bright/color/contrast)
- Door release
- Volume control
- Automatic recording
- Manual recording

2. Divert, If No Answer: If nobody answers the call in 30s when receives call from door station, diverts the call to the phone.

At this mode, the monitor will shut off the screen after diverting successfully, but you can still use it in normal.

Note:

- * The divert number should be set via monitor.
- * The time limited with the phone is 90s.
- * The status bar on main menu page will show "↔" icon.
- * Touch  icon on the screen to exit.

BASIC OPERATIONS

Setting divert number

On main menu page,touch **[Phone]**->**[Divert]**.

Total 3 telephone numbers can be set,touch the telephone number frame,then input the number by touching the digital keypad.



* Touch  icon on the screen to save the setting.

* Touch  icon on the screen to cancel.

Note:

* The divert number will be carried on in sequence if setting 2 / 3 telephone numbers.

Viewing calling records

All calls from door station or other monitors will be recorded and can be reviewed afterwards.

On main menu page, touch**[Call Record]** icon, the most recent call records are displayed.

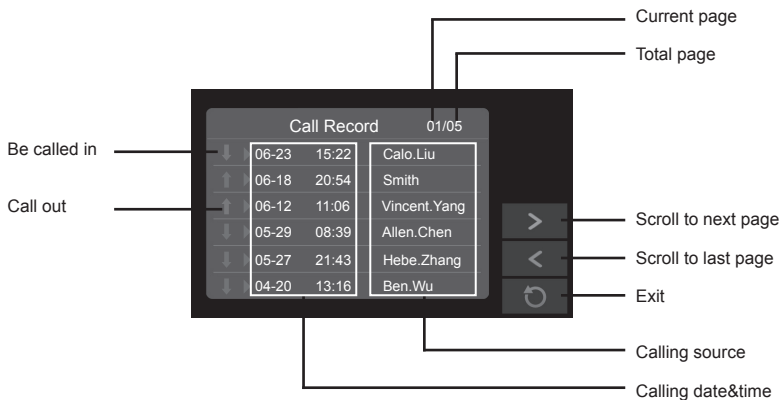

BASIC OPERATIONS

You can review who is calling at some time.

1. Touch one of the calling list.
2. Touch  icon to show the caller's image.



Note:

- * If the arrow display in red, that means the call is missed.
- * If the missed calls have been reviewed,the arrow will change to blue.
- * If it's blue,that means the call is answered.
- * Max. 100 calling records can be displayed
- * When the capacity is full,the oldest calling records will be deleted automatically to make room for new records.

SMS function

The messages received or sent out can be reviewed on monitor, and you can write messages between monitors.

1.Reviewing received messages:

- On main menu page,touch **[SMS]->[Inbox]** icon,the most recent received messages will be displayed.
- Select one of the messages to view the contents.

2.Reviewing sent out messages:

- On main menu page,touch **[SMS]->[Outbox]** icon,the most recent sent out messages will be displayed.
- Select one of the messages to view the contents.

Note:

It's available to reply messages or delete messages on Inbox/Outbox page.

Use "<" or ">" to scroll pages.

Touch  icon on the screen to exit.

BASIC OPERATIONS

Motion detect function

This function is available only if the setting of **Motion Detect Enable** is selected.

This function should make effective by door station with motion detection.

Follow the steps:

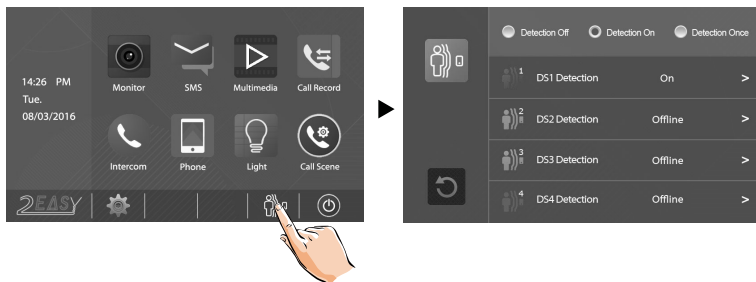

- **Detection off:** close all motion detections of door station.
- **Detection on:** activate the motion detect function, the door station motion detection should be activated individually.
- **Detection once:** respond motion detect function immediately, the door station motion detection should be activated individually.

Setting door station detection:

The following is taken door station1 for example.

1. On main menu page, touch icon.
2. Touch DS1 Detection item. (the door station with motion detector should be online)

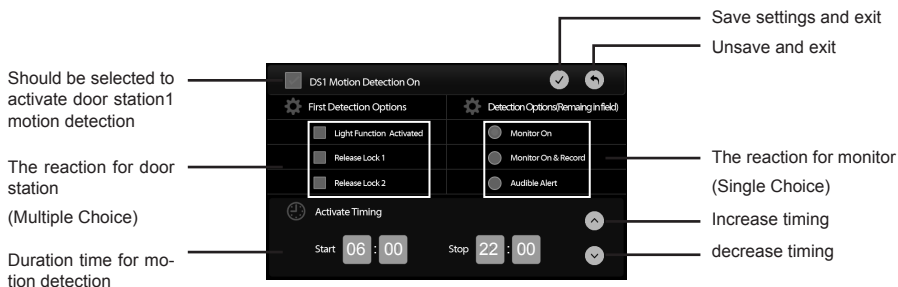





* The detection settings for other door stations are the same as door station1.

***On main menu page, touch [Multimedia]->[Motion Detection] icon, the most recent motion detect records are displayed.**

SETUP INSTRUCTIONS

Setting date and time

You can correct the current date and time at any time by following the procedure below.

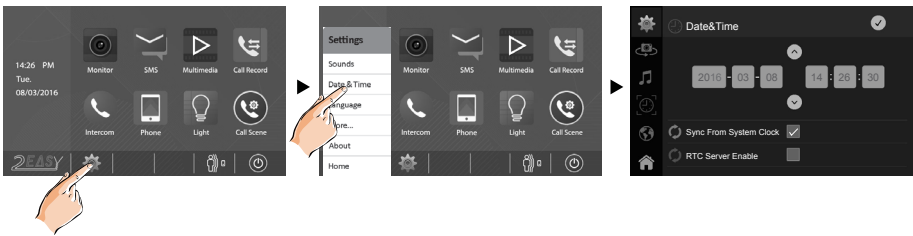

1. On main menu page, touch  settings icon -> **[Date&Time]**. Or directly touch current date and time area in shortcut to enter **Date&Time** setting page.
2. Touch the setting target of month, date, year, hour, minute and second individually, then touch  /  icon to change the value.
3. When the setting has finished, touch  to save the settings.





- Note:** 1. You can also synchronize the system time.
2. Touch  icon to exit and return to main menu page.

Setting ring tone

The ring call tone can be set individually to distinguish different calling sources. Total 20 tones can be selected.

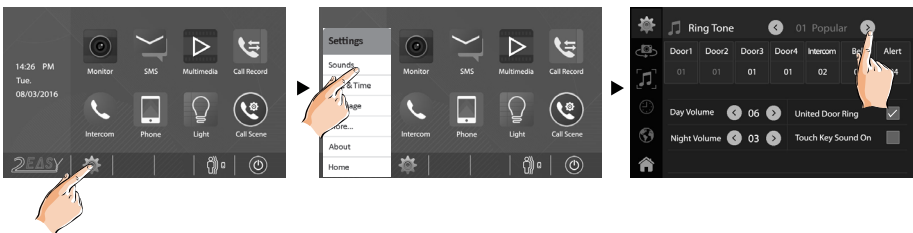
1. On main menu page, touch  settings icon -> **[Sounds]**.
2. Touch the setting target of door tone, intercom tone, door bell tone and alert tone individually, then touch  /  icon to change the tone. Settings will perform immediately.





- Note:** 1. If the door ring mode is selected to United, the ring tone of Door1/2/3/4 must be the same.
2. Touch  icon to exit and return to main menu page.

SETUP INSTRUCTIONS

Setting ring volume

The day/night ring volume can be set individually. The setting range is 0-9.

- On main menu page, touch  settings icon -> **[Sounds]**.
- Select the **Volume** setting item, touch  /  icon to adjust the levels. Settings will perform immediately.

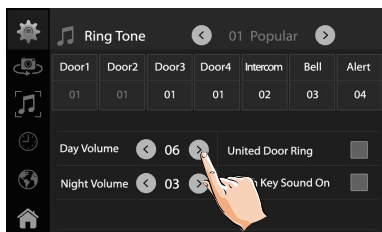



Note: 1. The day time is from 06:00am to 18:00pm. the night time is from 18:00pm~06:00am.

2. Touch  icon to exit and return to main menu page.

Enabling/Disabling the operation sound

You can make a beep sound for the monitor when touching the screen.

1. On main menu page, touch  settings icon -> **[Sounds]**.
2. Click **Touch Key Sound On** setting item, when " ✓ " symbol is displayed in the frame  , the setting is activated. Click the item again to cancel.

Naming door station & camera

You can name the door stations & cameras by entering characters.

1. On main menu page, touch  settings icon -> **[More...]**.
2. Select door station to rename. A keypad is shown.

SETUP INSTRUCTIONS

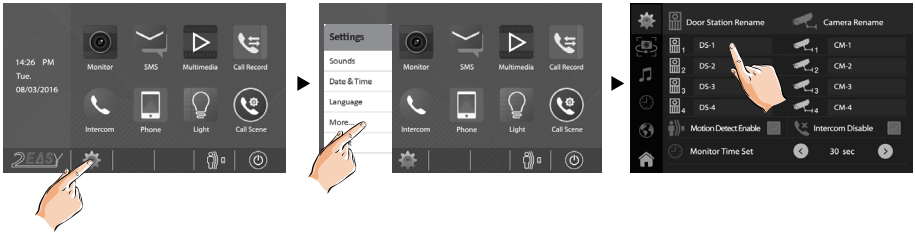

3. Rename the door station by touching the on-screen keypad.

* Up to 12 characters can be entered for a name.

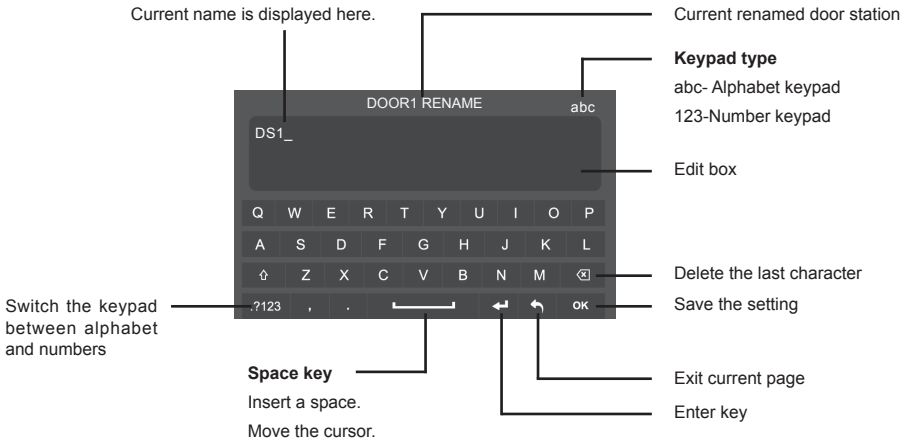

Setting monitor time

The monitor time can be changed at any time. It's available to set 30s,40s,50s,1min,2min,3min, 4min,5min,6min,7min,8min,9min,10min.



* 30s is the default monitor time.

1. On main menu page, touch settings icon -> **[More...]**.
2. Select **Monitor Time Set** item.
3. Touch / icon to adjust the levels. Settings will perform immediately.

SETUP INSTRUCTIONS

Enabling/Disabling motion detect function

You can make it possible (ENABLE) or not (DISABLE) to activate motion detect function from this monitor.

1. On main menu page, touch  settings icon -> **[More...]**.
2. Click **Motion Detect Enable** setting item, when "✓" symbol is displayed in the frame , the setting is activated. Click the item again to cancel.



*If this setting item has not been selected, the motion detect function is forbidden, and the **Montion detect** icon  will not display on main menu page.

Enabling/Disabling intercom function

You can enable or disable intercom function from this monitor.

1. On main menu page, touch  settings icon -> **[More...]**.
2. If select **Intercom Disable** item, the intercom function is forbidden.

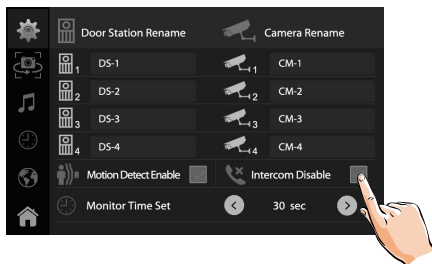

*In default setting, intercom function is enable for the monitor.

SETUP INSTRUCTIONS

Changing the display language

The default language can be customized. But you can change it to the language you need at any time. Follow the steps:



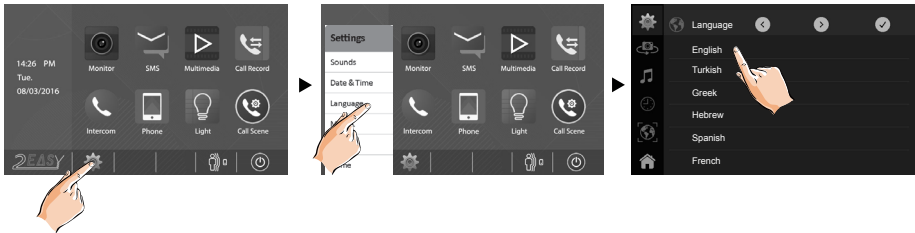

- On main menu page, touch  settings icon -> **[Language]**.
- Touch desired language and select  to save the setting.



*If the target language is not found in the window, touch  /  icon to scroll next page.

Restoring to default setting

The restore to default function allows the user to recover the settings to factory setting.

- On main menu page, touch  settings icon -> **[About]**.
- Touch  icon, a message of "Restore To Default?" will be asked.
- Touch  icon to start the restore. Touch  icon to cancel.

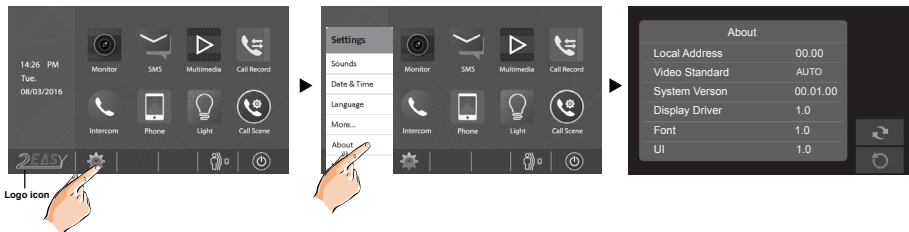

* Touch **[Logo]** icon to enter **About** page in shortcut.

* If restoring to default is completed, a sound beep will be sent out.

SYSTEM CONFIGURATIONS

Entering installer setup

- On main menu page, touch **[Logo]** icon to enter **About** page.
- When the screen stay in **About** page,press **[UNLOCK]** button on front panel and hold for 2 seconds.
- A keypad is shown.

Refer to the followings:

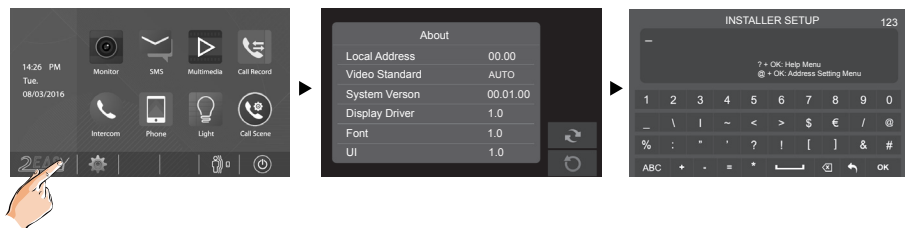

■ Entering Help page

Input the key “?” and ok” to open **Help** instructions menu.

Refer to the followings:

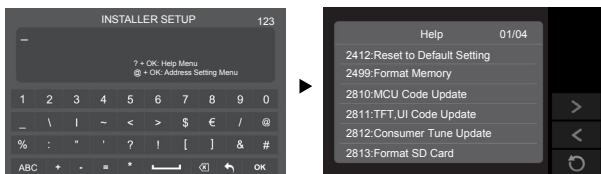

Code	Setting Item	Code	Setting Item
2412	Reset to Default Setting	8018-8020	Video Display Standard
2499	Format Memory	8040-8050	LED Color Setting For Calling
2810	MCU Code Update	8051-8055	LED Color Setting For Standby
2811	TFT,UI Code Update	8300-8301	Auto Rec ON/OFF
2812	Consumer Tune Update	8302-8303	Manual Rec ON/OFF
2813	Format SD Card	8401-8499	Unlock Time
2910	Broadcast Namelist	9006-9007	Unlock Alert Disable/Enable
8004-8005	Guard Unit Enable	9008-9010	Tune Source For Default/Custom
8008-8009	Date Format	9011-9012	NameList First Name."00/01"
8010-8011	Unlock Mode:Close/Open	9017-9019	Touch Key Sensitivity Adjust
8012-8013	Time Format:12 hour/24 hour	9020-9021	Hearing Aid Function On/Off
8016-8017	Bypass Enable/Disable	9030-9039	Fish Eye Control

SYSTEM CONFIGURATIONS

■ Entering Address setting page

Input the key “@ and ok” to open **Address Setting** menu.

Refer to the followings:

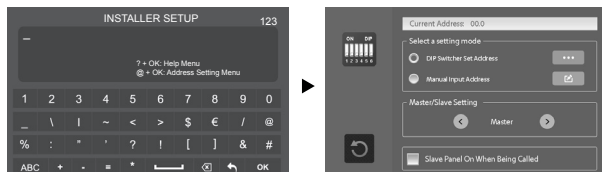

Setting master/slave monitor

Maximum 4 monitors can be connected in one apartment, one master monitor together with 3 slave monitors, so you should set the address correctly.(Note:must have one monitor to be set as a master monitor)

- Select Master/Slave Setting item,touch ◀ / ▶ icon to scroll to next item,settings will perform immediately.

Setting slave monitor panel on

In default mode,when receiving a call,the master and slave monitors will ring at the same time,and just the master monitor can display the image while the slave monitors will not. But the settings can be changed,you can set the master monitor and all the slave monitors to panel on at the same time when being called.

- Click “ Slave Panel On When Being Called” item,when “ ✓ “ symbol is displayed in the frame ■ , the setting is activated.
- Click the item again to cancel.

Setting user code

On DT system,every apartment must assign a unique identification called **User Code**.

There are two setting modes for address setting,DIP switcher and manual input .

SYSTEM CONFIGURATIONS

DIP Switcher Set Address

The DIP switches are used to set the user code for each monitor. Total 6 bits can be configured.

- Bit-1 to Bit-5 are used for user code setting. The value range is from 0 to 31, which have 32 different codes for 32 apartments.
- When multi monitors need to be installed in one apartment, these monitors should use the same user code, and the master/slave mode should be set on the monitor. (Details refer to the section of **Setting Slave Monitor**)
- Bit-6 is bus line terminal switch, which should be set to “ON” if the monitor is at the end of bus line, otherwise be set to “OFF”.

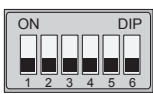

Bit-6 switch setting

Bit state	Setting	Bit state	Setting
	When monitor is not at the end of bus line.		When monitor is at the end of bus line.

This monitor is assigned with DIP setting instructions.

On Address setting page, select DIP Switcher Set Address setting mode firstly, then touch icon, total 32 DIP codes will be displayed.

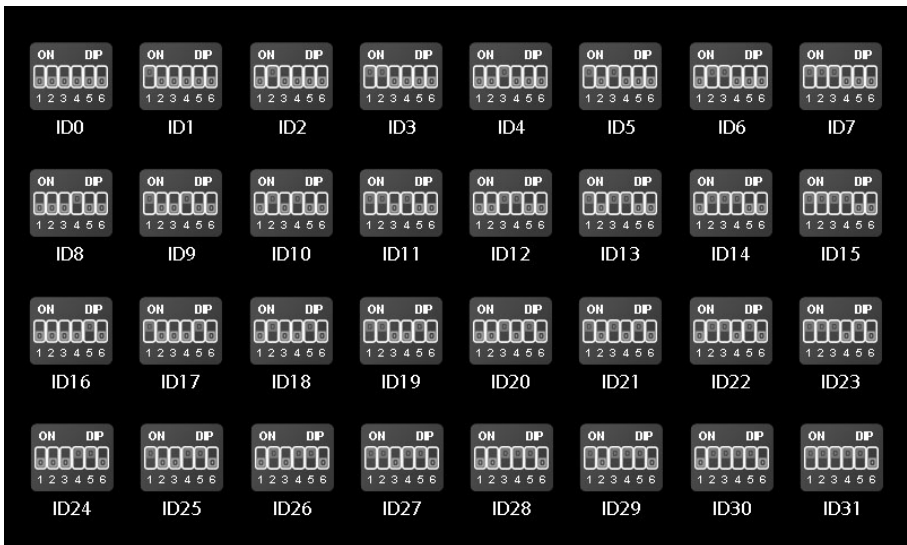

SYSTEM CONFIGURATIONS

Manual Input Address

It's available to input the address manually for this monitor.

- Total 32 numbers to be set, from 00~31.
- When multi monitors need to be installed in one apartment, these monitors should use the same user code, and the master/slave mode should be set on the monitor. (Details refer to the section of **Setting Slave Monitor**)

1. On Address setting page, select Manual Input Address setting mode, then touch  icon, a keypad will be displayed.

2. Input the code by touching the digital number.

3. Touch "OK" key to save, code setting complete.

4. Touch "↶" key to exit.

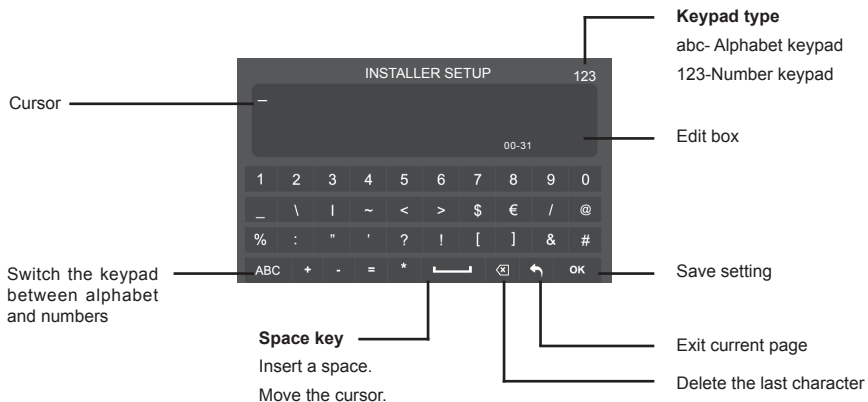

APPENDIX

Specification

Power supply:	DC 20~28V
Power consumption:	Standby 0.29W; Working 7W
Communication:	Hands-free
Screen:	7 Inch digital color TFT
Display Resolutions:	800*3(R, G, B) x 480 pixels
Video signal:	1Vp-p, 75Ω, CCIR standard
Mounting:	Surface wall-mount
Color:	White,Black
Wiring:	2 wires, non-polarity
Dimension:	132(H)×226(W)×18(D)mm

DT-ENG-47MG(V2)-V1

The design and specifications can be changed without notice to the user. Right to interpret and copyright of this manual are preserved.