



2-Wire Video Intercom System



① Read this manual carefully before using the product, and keep it well for future use.

Introduction

The monitor is designed with 4 inch screen, it provides a resolution of 320x240 pixels with high quality image display, and it equipped with a handset to communicate. The touch sensitive button makes the operation more easily.

Parts and Function

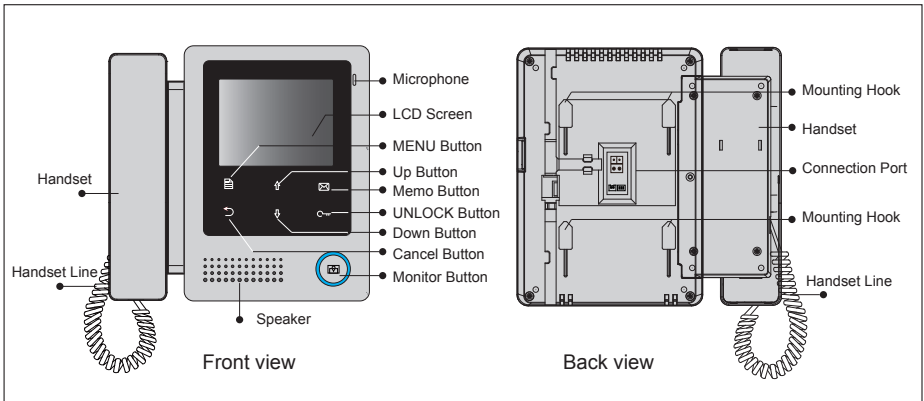

Terminal Description

L1,L2: Bus terminal

SW+,SW-: Door bell call button connection port

DIP switches: Total 3 bits can be configured.

Bit1: reserve

Bit2: reserve

Bit3: to set the video impedance matching, when the video signal is not so good, set bit3 to "on".

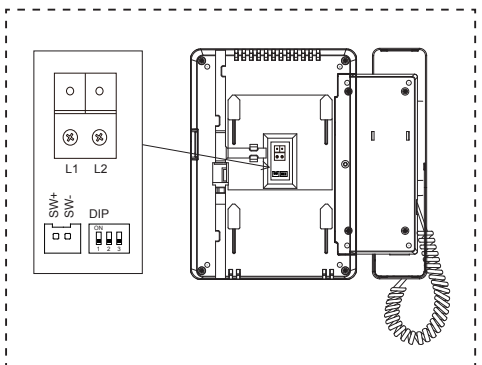

Unit Mounting

Accessory contents:

Accessories include a Bracket, two 4X25 screws (use to fasten the Mounting Bracket), 2 wire connectors (use to connect with Monitor).

Installation steps:

Installation height for indoor monitor usually is 145~160cm(refer to sketch map).

Wire the cable correctly(see the later connection chapter) then hang the Monitor on the Mounting Bracket firmly.

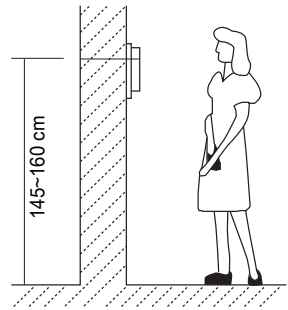
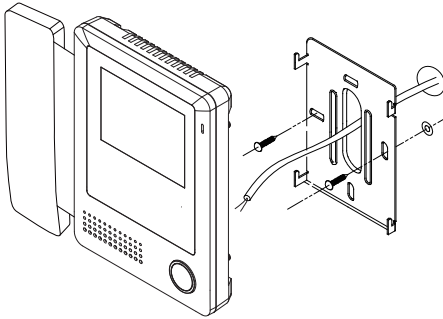

About Main Menu

The main menu is your starting point for using all the applications on your monitor. You can customize your main menu to display applications, logos, and languages.

To open the main menu page, tap 

Menu key one time on the monitor.

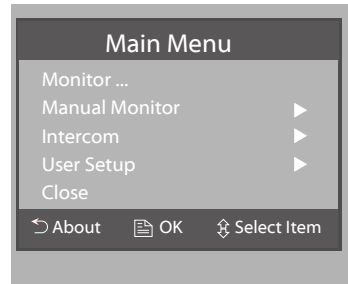

Basic Operation Instruction

Answering a Door Call

- Press **CALL** button on door station. The monitor rings, and the visitor's image will be seen on screen. If nobody answers the call, the screen will turn off in 30 seconds automatically.

- Pick up handset to talk with the visitor, the talking duration time is 90s. To end the conversation, please hand up the handset. If the system connects two or more Monitors, pick up any Monitor, the others will be automatically shut off.

Door Release

During talking state, Press **UNLOCK** button to open the door for the visitor.

Entrance Monitoring

When the monitor is in standby mode, press **MONITOR** button(or select **Monitor ...** item on main menu page), The screen can display the view of outside. If multi door stations are installed, select **Manual Monitor** item to enter camera switch mode. Select **Camera 1 ...** item, the screen will display the image from the first door camera. Similarly. Select **Camera 2 ...** item to choose the second one. Select **Camera 3 ...** item to choose the third one. Select **Camera 4 ...** item to choose the fourth one.

To end the monitoring, please tap **MONITOR** button again.

Intercom Function

Intercom function can be initiated by any monitor when multi monitors are installed.

When the monitor is in standby mode, pick up handset, the **Intercom** item on main menu page will be selected, press **MENU** button to enter.

Intercom Call: User in one apartment can call other apartments in the system, the namelist will be created automatically by the system. Select a name on the screen, use **↑** / **↓** button to move upward / downward to select, then press **MENU** button to dial.

Note:

1. Press "MENU " button again to redial.
2. The user code of each monitor must set different

Inner Call: If multi Monitors are installed in the same apartment, select Inner Call, all the other Monitors will ring at the same time, whichever Monitor an-

swers the call, conversation is started.and the other monitors will stop ringing at the same time.

(Note:the user code of all monitors must be same.)

Direct Call Guard unit: A Monitor can be assigned as Guard Unit Monitor; when the Guard Unit Monitor answers the call, conversation with the guard person is started..

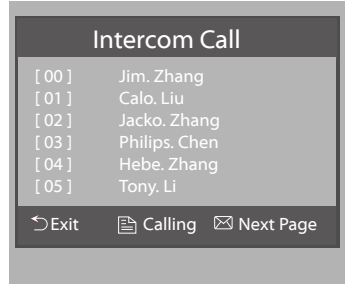

Basic Setup Instruction

Ring Tone Setting

Select **User Setup** item on main menu page to enter setup page. Select **Door Station Call Tone**, **Intercom Call Tone** or **DoorBell Tone** item, There are 12 pieces ring tones can be selected.use \uparrow / \downarrow button to select last/next ring tone, press **MENU** button to save and exit.

Door Station Call Tone: set the ring tone calling from outdoor station.

Intercom Tone: set the ring tone calling from other apartments.

DoorBell Tone: set the ring tone calling from door bell.

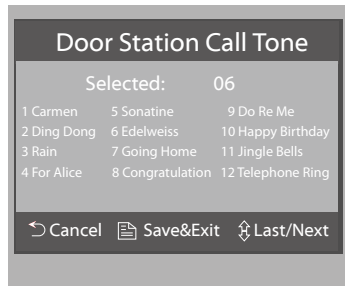
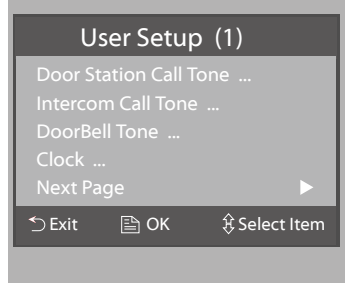

Monitor Time Setting

Select **Manual Monitor** item on main menu page, then select **Monitor Time Set...** item. Use \uparrow / \downarrow button to increase / decrease the value, press **MENU** button to confirm and return last page.

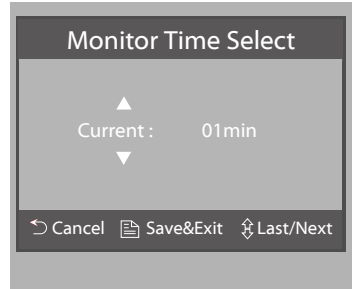

Screen Setting

During monitoring or talking state, press **MENU** button, the **ADJUST MENU** will be displayed.

Use \uparrow / \downarrow button to select the adjustment item, use \boxtimes **Memo** button to change the value.

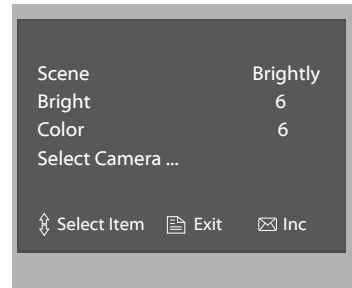

- The first item is **Scene** mode selection: Total 4 screen modes can be selected in sequence: **Normal**, **User**, **Soft** and **Bright**. Please note whenever you modify **Brightness** or **Colour** item, **Scene** item will be set to **User** mode automatically.
- The **Brightness** and **Colour** item is for the image quality setting, adjust the value to get the best image you like.

Note that all the modifications will be done immediately after the operation. Press **MENU** button to quit the adjust page.

Installation Setting

Enter Installation Setup Page

Step1: Press \curvearrowright **About** button on main menu page to enter about information

Step2: Press **UNLOCK** button and hold for 2s.

Step3: Input 4 digits number according to the following information.

Step1

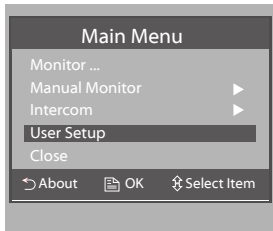

Step2

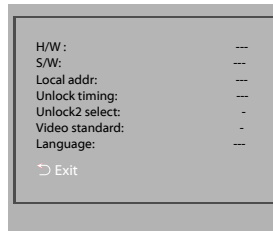

Step3

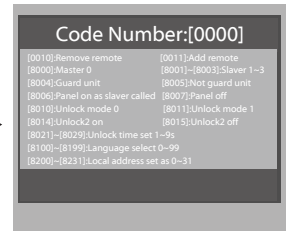

How to set the monitor as a Guard Monitor

A Monitor can be assigned as Guard Unit Monitor; when the Guard Unit Monitor answers the call, conversation with the guard person is started..

The code number of 8004 is used to set the monitor as a guard unit monitor and 8005 is used to cancel this function.

How to set the monitor panel on

In default mode,when receive a calling,the master and slave monitors will ring at the same time,and just the master monitor can display the image while the slave monitors can not.But the settings can be changed,you can set the master monitor and all the slave monitors to panel on at the same time when receiving a call, just input the code number of 8006 on each slave monitor.

How to set the unlock parameter

Unlock mode:

There are two unlock modes:

- 1.power-on- to-unlock type:unlock mode=0(by default)
- 2.power-off-to-unlock:unlock mode=1.

The code number of 8010 is used to set the unlock mode to 0

The code number of 8011 is used to set the unlock mode to 1

Unlock time:

The unlock time can be changed by yourself at any time.it can be set from 1 to 9 seconds.

The code number from 8021 to 8029 are used to set the unlock time to 1~ 9 seconds.

2 locks control:

The monitor can be set to control 2 locks while you should set the unlock2 item to “on “ state.

The code number of 8015 is used to set the unlock2 off that it can only control one lock.

The code number of 8014 is used to set the unlock2 on that it can control two locks.

Note:1. During talking or monitoring state, UNLOCK button,two unlock icons will be showed. Use ↑ / ↓ button to select the item you want, and press UNLOCK or MENU button to release the corresponding door,select ↻ item to exit.

2. Restore to default operation will not change the parameters setting.

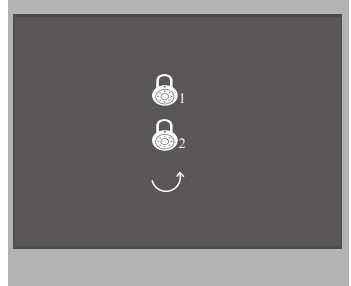

How to set the slave monitor address

Maximum 4 monitors can be connected in one apartment,one master monitor together with 3 slave monitors, so you should set the address correctly. (note:must have one monitor to be set as master monitor)

The code of 8000 is used to set the master monitor.

The code of 8001 is used to set the first slave monitor .

The code of 8002 is used to set the second slave monitor .

The code of 8003 is used to set the third slave monitor .

How to set the menu language

The monitor can support multi languages and it is so simple and fast, just input the corresponding language code on monitor.The language code number are as follows:

8101: English	8107: Portuguese	8113: Russian
8102: French	8108: S-Chinese	8114: Slovakia
8103: Spanish	8109: T-Chinese	8115: Hungry
8104: Italian	8110: Greek	8116: Czech
8105: German	8111: Turkish	8117: Hebrew
8106: Dutch	8112: Polish

Note:

1. the monitor can only support 4 languages. English,French,Spanish and German are default.But you can customize any 4 languages by yourself.
2. we reserve the copyright to add languages without notice to users.

How to set the address for monitor

Each monitor should be assigned an address in the system, total 32 addresses can be configured, the code number of 8200 to 8231 is used to controlled the address of 00 to 31. Please refer to the following table.

Input No.	User Code	Input No.	User Code	Input No.	User Code
8200	Code=0	8211	Code=11	8222	Code=22
8201	Code=1	8212	Code=12	8223	Code=23
8202	Code=2	8213	Code=13	8224	Code=24
8203	Code=3	8214	Code=14	8225	Code=25
8204	Code=4	8215	Code=15	8226	Code=26
8205	Code=5	8216	Code=16	8227	Code=27
8206	Code=6	8217	Code=17	8228	Code=28
8207	Code=7	8218	Code=18	8229	Code=29
8208	Code=8	8219	Code=19	8230	Code=30
8209	Code=9	8220	Code=20	8231	Code=31
8210	Code=10	8221	Code=21		

Specification:

- Power Supply: DC 24V
- Power Consumption: Standby 6mA; Working status 194mA
- Monitor Screen: 4 Inch color LCD
- Display Resolutions: 320(R, G, B) x 240 pixels
- Video Signal: 1Vp-p, 75Ω, CCIR standard
- Wiring: 2 wires, non-polarity
- Dimension: 186(H)×190(W)×26(D)mm

Precautions

- 1) All components should be protected from violence vibration. And not allow to be impacted, knocked and dropped.
- 2) Please do the cleanness with soft cotton cloth, please do not use the organic impregnant or chemical clean agent. If necessary, please use a little pure water or dilute soap water to clean the dust.
- 3) Image distortion may occur if the video monitor is mounted too close to magnetic field e. g. Microwaves, TV, computer etc.
- 4) Please keep away the monitor from wet, high temperature, dust, caustic and oxidation gas in order to avoid any unpredictable damage.
- 5) Must use the right adaptor which is supplied by the manufacturer or approved by the manufacturer.
- 6) Pay attention to the high voltage inside the products, please refer service only to a trained and qualified professional.



The design and specifications can be changed without notice to the user. Right to interpret and copyright of this manual are preserved.