

1.About DT-BDU Unit

Discription:

The BDU unit is bus amplifier unit and networking component designed for DT 2-wire system. It has three work modes:Repeater mode, Router mode and Gateway mode.

2. Terminal Description

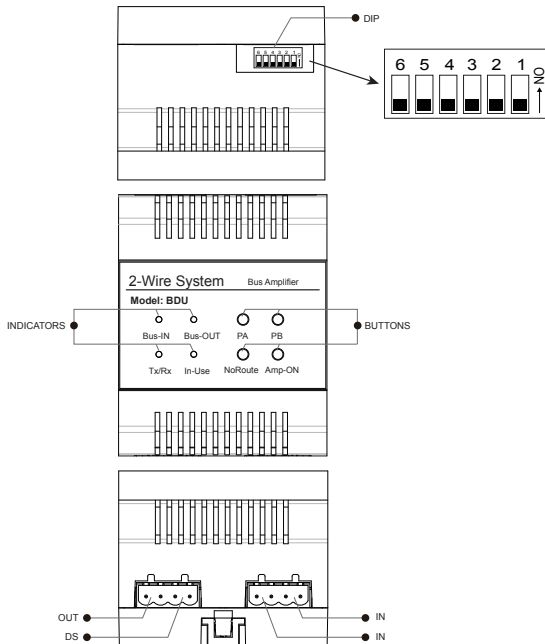













DIP Setting:

Bit-1 to Bit-2 are used to BDU working modes setting.

Bit-3 to Bit-5 are used to address settings.

Bit-6 is used to video Impedence match.

The detail settings of DIP are as follows:

Bit	Bit State	Description
Bit-1~Bit-2		Set to the Repeater mode.
		Set to the Router mode.
		Set to the Gateway mode.
		Reserved.
Bit-3~Bit-5		Set to the first DT-BDU.
		Set to the second DT-BDU.
		Set to the third DT-BDU.
		Set to the fourth DT-BDU.
		Set to the fifth DT-BDU.
		Set to the sixth DT-BDU.
		Set to the seventh DT-BDU.
		Set to the eighth DT-BDU.
Bit-6		Used to video Impedence match, set to ON.

INDICATORS:

- 1.Bus-IN: Always on when connect to net.
- 2.Bus-OUT: Always on when connect to monitor.
- 3.Tx/Rx: Flashes when communicating.
- 4.In-Use: Always off when in standby mode.

BUTTONS:

- 1.PA, PA: Video Amplifier Gain adjust.
- 2.NoRoute, Amp-ON: Debug button.

3. Working Mode Wiring.

3.1 Repeater Mode (Line amplifier): BDU can extend the distance of DT system when works in repeater mode. As follows:

Max 140m from the first door station to BDU

Max 140m from the last indoor monitor to BDU

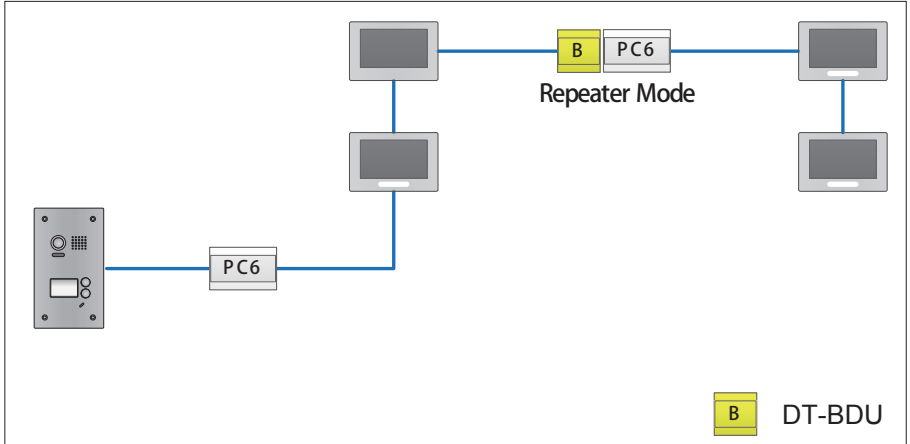

Wiring diagram:

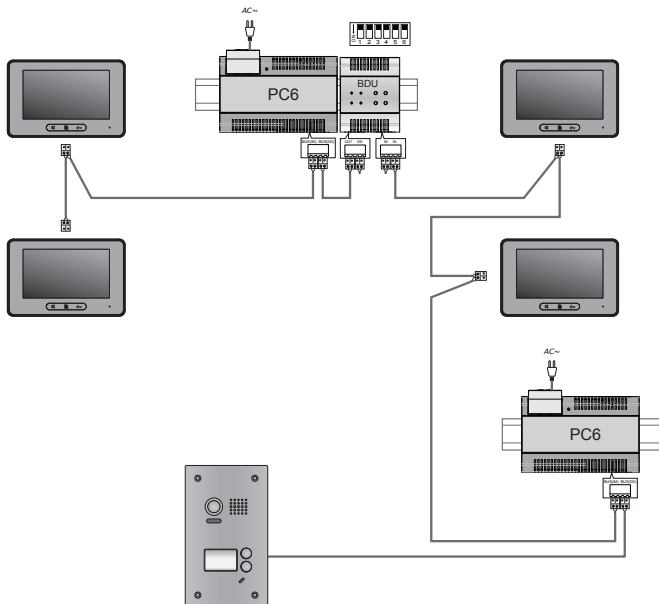

3.2 Router Mode: In this mode, the system can connect up to 8 BDUs, and each BDU can connect up to 32 monitors.

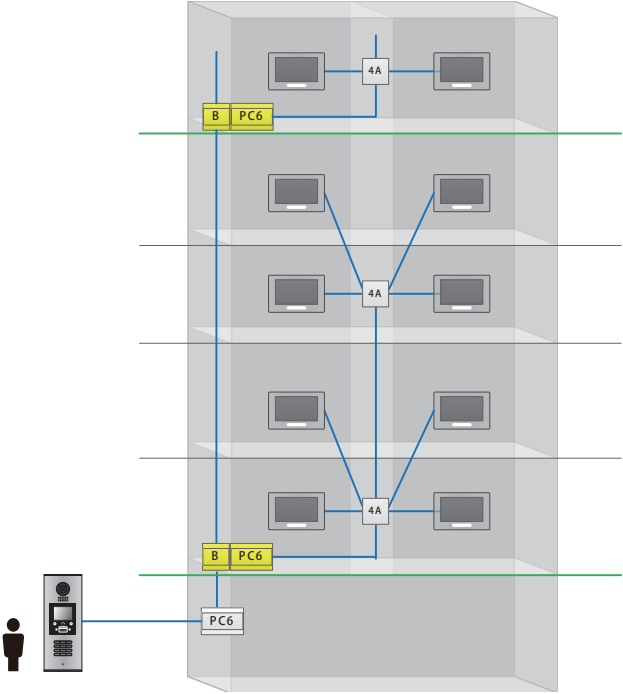

 DT-BDU

Wiring diagram:

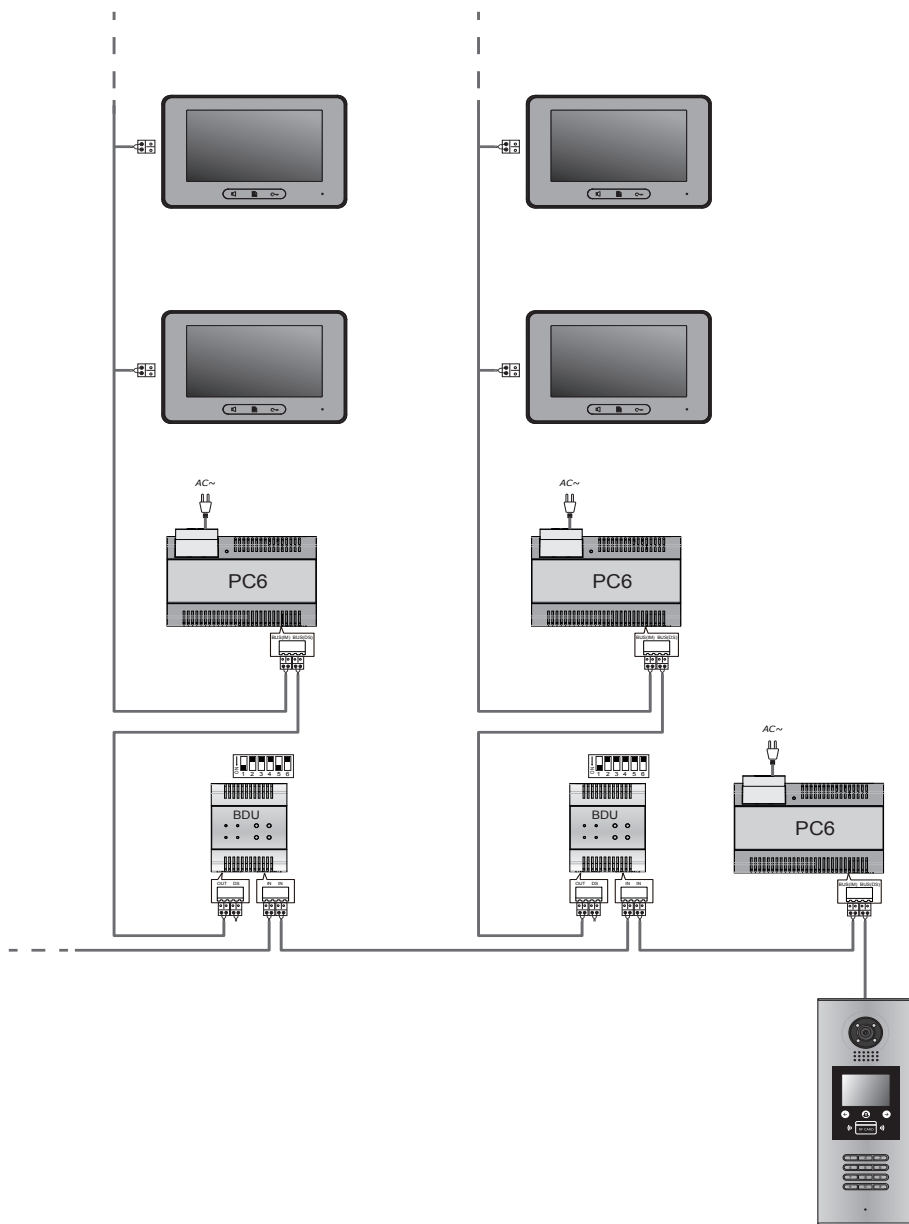

3.3 Gateway Mode: In this mode, the first door station can call all the monitors and can connect up to 8 BDUs, and each BDU can connect up to 32 monitors.

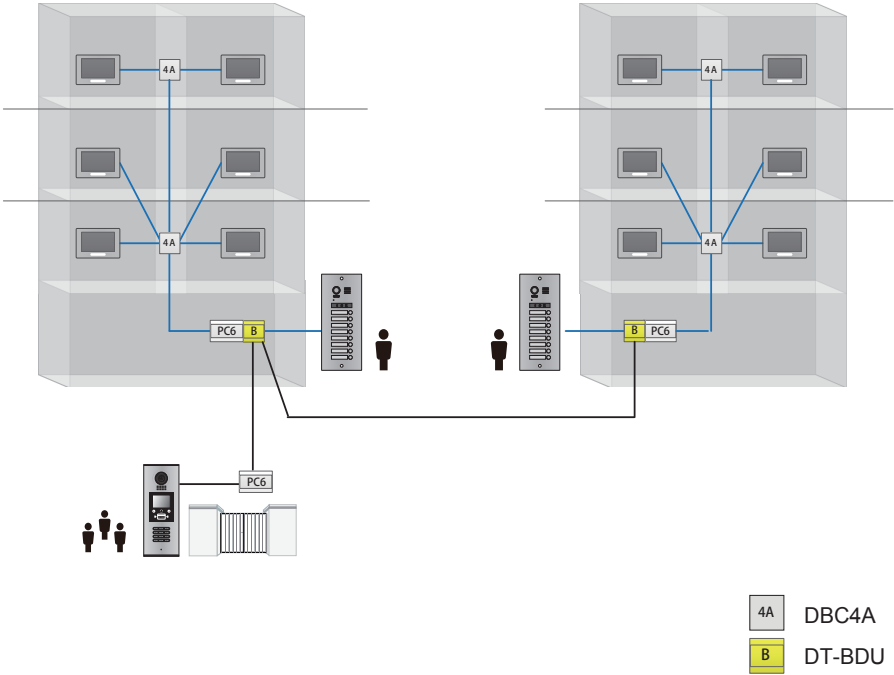

Wiring diagram:

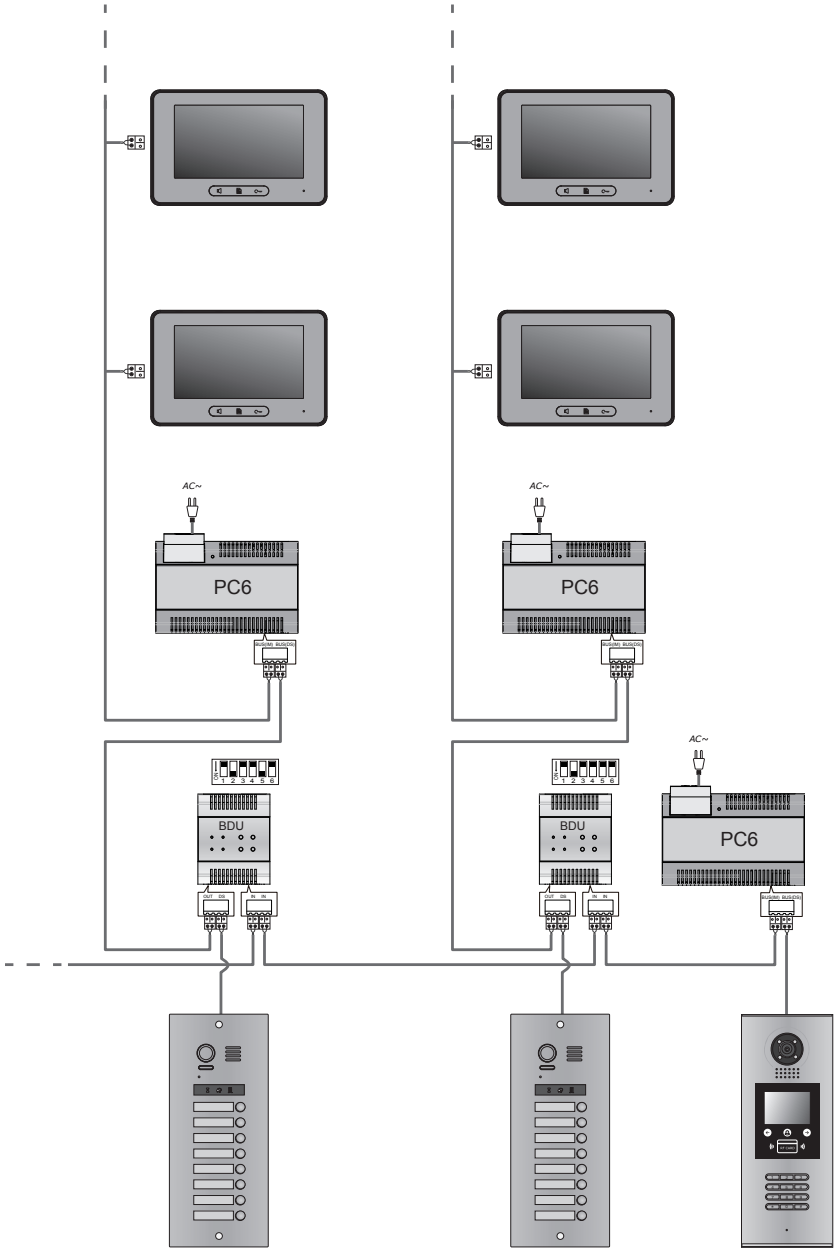

4. Specification

- Power Supply : DC24V;
- Power consumption: Standby 13.5mA; Working 156mA;
- Working Temperature: $-15^{\circ}\text{C}\sim+55^{\circ}\text{C}$;
- Wiring: 2 wire, non-polarity;
- Dimension: 90(H) \times 72(W) \times 60(D)mm.

The design and specifications can be changed without notice to the user. Right to interpret and copyright of this manual are preserved.
