

2 WIRE SYSTEM

DT608 Series

Fisheye door station with proximity access control

USER MANUAL

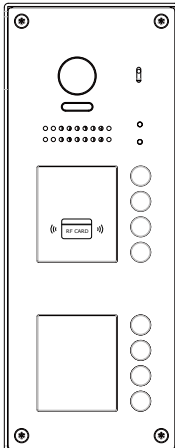

DT608/ID/FE-S8

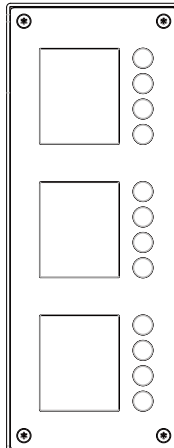

EP608-S12

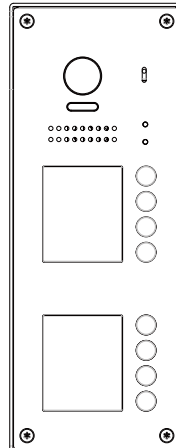

DT608C-S8

- Please read this manual carefully to ensure safe and correct operation.
- Keep this manual well for future reference.

CONTENTS

PARTS AND FUNCTIONS	3
Part Names.....	3
Mounting.....	3
Terminal Description.....	4
BASIC FUNCTIONS	5
Unlock Operations.....	5
Fisheye Camera.....	5
External Motion Detection.....	5
SETUP INSTRUCTIONS	6
Functions Setting Up.....	6
Setting Door Station Address.....	7
Setting Door Station Calling Mode.....	7
Setting Camera N/P Standard.....	9
Setting Prompt Voice.....	9
Setting Prompt Voice Volume.....	10
Setting Unlock Mode.....	10
Setting Unlock Time.....	11
Setting Nameplate Illumination Mode.....	11
Setting Night View LED Illumination Mode.....	12
Setting Ring-back Tone.....	12
Setting Image Display Mode.....	13
RAINY_COVER Configure.....	14
Registering ID Card.....	15
Restore To Default.....	17
WIRING	18
Connecting Electric Lock.....	18
As The Villa System Door Stations.....	19
As The Apartment System Door Stations.....	20
APPENDIX	21
Precautions.....	21
Specification.....	21
Cables and Requirments.....	22

PARTS AND FUNCTIONS

Part Names

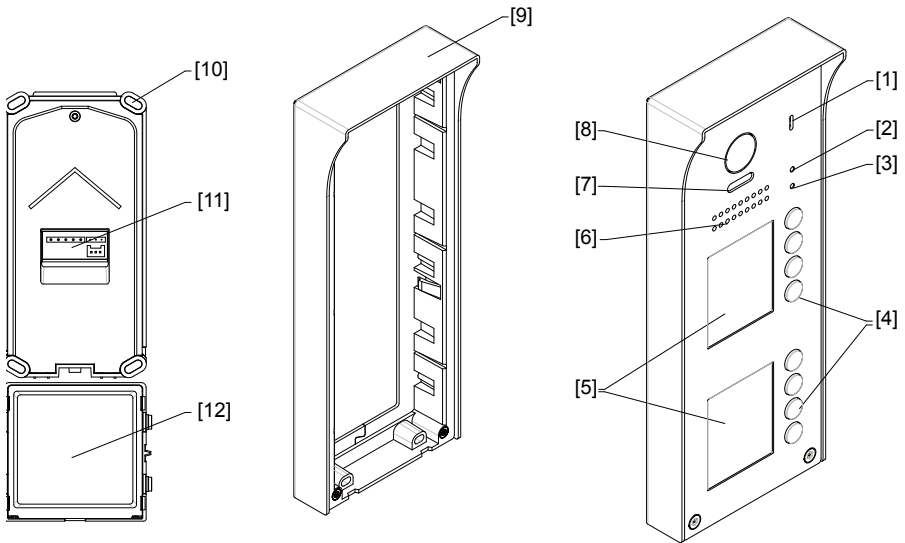

- | | | | |
|----------------------|-----------------|--------------------|--------------------------|
| [1] Microphone | [4] Call button | [7] Night view LED | [10] Mounting hook |
| [2] UNLOCK indicator | [5] Nameplate | [8] Camera lens | [11] Connection port |
| [3] CALL indicator | [6] Speaker | [9] Rainy cover | [12] External key module |

Mounting

The installation height is suggested to 145~160cm.

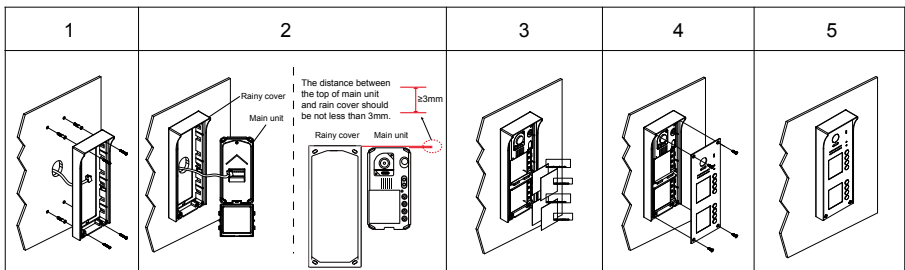

1. Drill holes in the wall to match the size of screw stoppers, then attach the rainy cover to the wall.
2. Connect the cable correctly, and attach the main unit to the rainy cover. The distance between the top of main unit and rain cover should be not less than 3mm.

PARTS AND FUNCTIONS

3. Install the name plate.
4. Attach the front panel to the rainy cover.
5. Use the special screwdriver and the screws to fix the panel.

Terminal Description

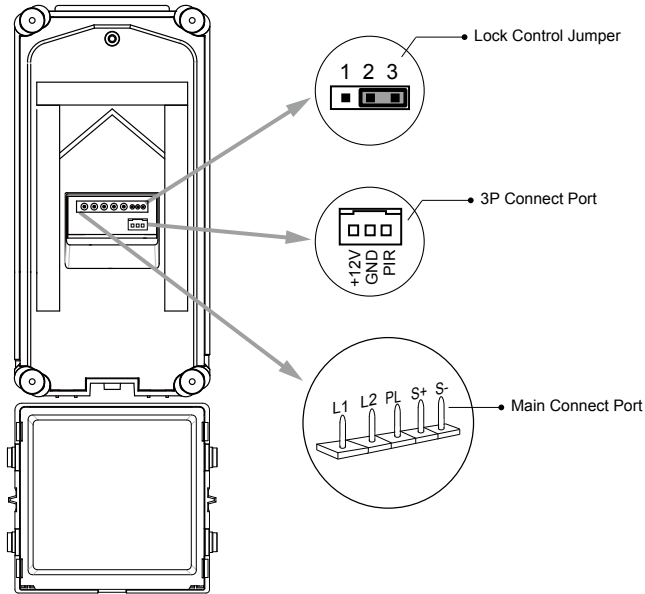

Lock Control Jumper: To select the lock type.

3P Connect Port: 1. If the external key module is detected online, the port will be automatically as a communication port;

2. If there is no the external key module, it will check whether the PIR function is enabled. If the PIR function is enabled, it will be as the detection port of the PIR;

3. If above cases are not activated, it can be used as exit button port.

Main Connect Port: To connect the bus line and the electronic locks.

- **L1,L2:** Connect to the bus line, no polarity.
- **PL:** External lock power input, connect to the power positive(power +).
- **S+:** Lock power(+) output.
- **S-:** Lock power(-) output, connect to the power(-) input of locks(only when using the door station to power the locks, if using the external power supply for the locks, the S- will not be connected).

BASIC FUNCTIONS

Unlock Operations

Unlocking of ID Card

When the registered user card has been shown to ID card window, the UNLOCK indicator lights up, the buzzer sounds, and the electric door strike is unlocked.

- If show the authorized user card, the buzzer will sound of beep+, and the UNLOCK indicator will light up.
- If show the unauthorized user card, the buzzer will sound of beep, beep, beep.

Fisheye Camera

Please note that this function requires the monitor with fisheye function to support.

The angle view is 170°, visitors in this angle view can be seen clearly and can be zoomed to see individuals up close via indoor monitor with fisheye function.

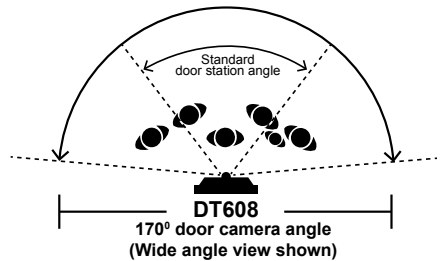

External Motion Detection

The door station is equipped with a terminal to connect external motion detector.

If the external motion detector is connected to the system, following functions will be effective:

If detect someone passing by, the door station can be activated operation to unlock or turn on light.

* Please contact with supplier for more details about detector connection.

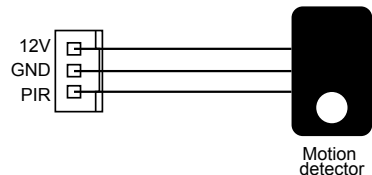

SETUP INSTRUCTIONS

Functions Setting Up

This section explains the settings of each function, please refer to the following table:

To perform the settings for the function you want, you should move away the metal front panel. Please refer to the sketch map.

Each operation is indicated by the lighting up of the **LED** indicator on the unit, and by the sounding of the buzzer.

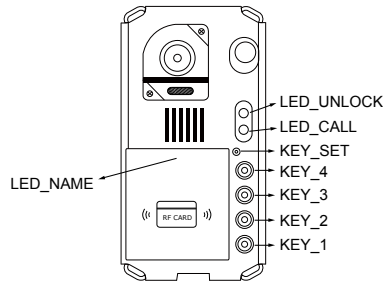

Main unit

Order	Setting items	Setting range	Default value
1	Setting door station address	0~3	0
2	Setting door station calling mode	Standard/Group calling mode	Standard calling mode
3	Setting camera N/P standard	N/P standard	P standard
4	Setting prompt voice	Max. 9 voices	Voice 1
5	Setting prompt voice volume	1~9	6
6	Setting the unlock mode	0:opened/1:closed	0:opened
7	Setting the unlock time	01 to 99 seconds	1 seconds
8	Setting the nameplate illumination mode	On/Off/Auto	On
9	Setting night view LED illumination mode	On/Off/Auto	Auto
10	Setting ring-back tone	Ringing one time Ring continuously No ring-back tone	Ringing one time
11	Setting image display mode	Alternate switching mode Zoom mode Full screen mode	Alternate switching mode
12	RAINY_COVER configure	Provide / not	Provide

SETUP INSTRUCTIONS

Setting Door Station Address

Total 4 addresses can be configured. It can be modified either before or after installation.

0 is default, to change the setting, please follow the steps:

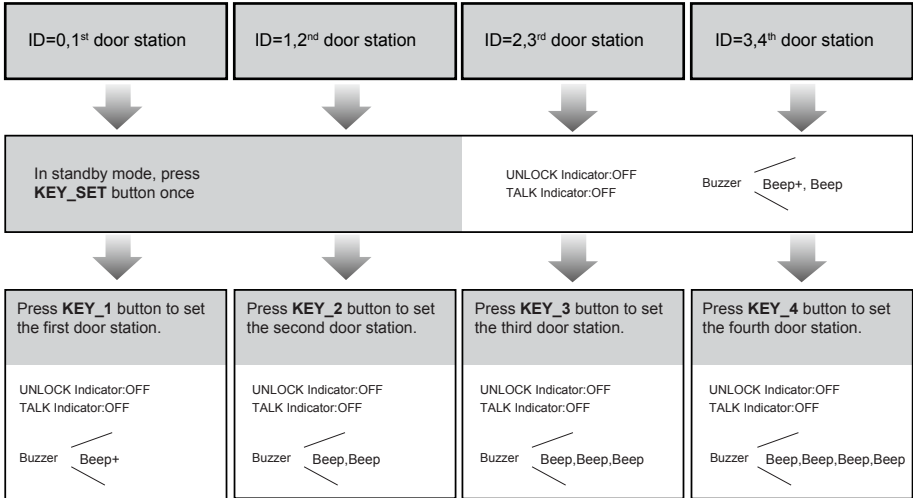

- If setting mode has not been exited, you can change the address of door station by pressing KEY1~4 freely.
- The **LED_NAME** indicator will always blink until exit out the setting mode.
- If without any operation in 10 seconds, it will exit out setting mode automatically.
- In this step,press **KEY_SET** button four times to exit out the setting mode manually.

Setting Door Station Calling Mode

There are two calling modes for door station.

As apartment system door station, the calling mode is **Standard calling** mode.

As villa system door station, the calling mode is **Group calling** mode.

Please know that the door station work in Standard calling mode by default.

SETUP INSTRUCTIONS

Each call button will respond different addresses when set in different calling mode. Refer to the followings for more informations.

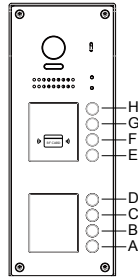

Apartment system door station

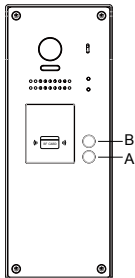

Villa system door station

1. Standard calling mode (Address range 01-08 by default)

Call button A: call the monitor with address **01** by default.

Call button B: call the monitor with address **02** by default.

Call button C: call the monitor with address **03** by default.

Call button D: call the monitor with address **04** by default.

Call button E: call the monitor with address **05** by default.

Call button F: call the monitor with address **06** by default.

Call button G: call the monitor with address **07** by default.

Call button H: call the monitor with address **08** by default.

2. Group calling mode

Call button A: Call all monitors in group address from 00~15. (one of the monitor should be set to 00)

Call button B, C, D, E, F, G, H: Call all monitors in group address from 16~31. (one of the monitor should be set to 16)

* More details about code setting for monitor, please refer to corresponding user manual .

To change this setting, please follow the steps:

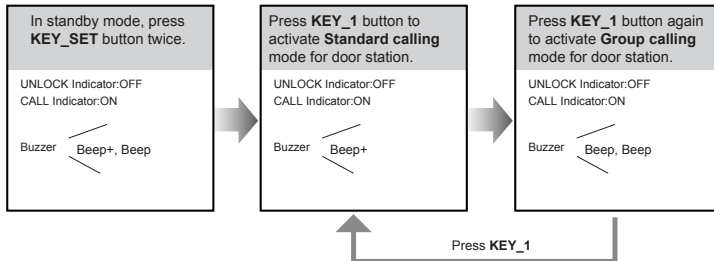

- If setting mode has not been exited, you can change the calling mode by pressing KEY1 circularly.
- The **LED_NAME** indicator will blink all the time until exit out the setting mode.
- If without any operation in 10 seconds, it will exit out setting mode automatically.
- In this step, press **KEY_SET** button three times to exit out the setting mode manually.

SETUP INSTRUCTIONS

Setting Camera N/P Standard

The standard of the camera can be adjusted at any time, that means the quality of image on screen can be set to differ.

P standard is default, to change the setting, please follow the steps:

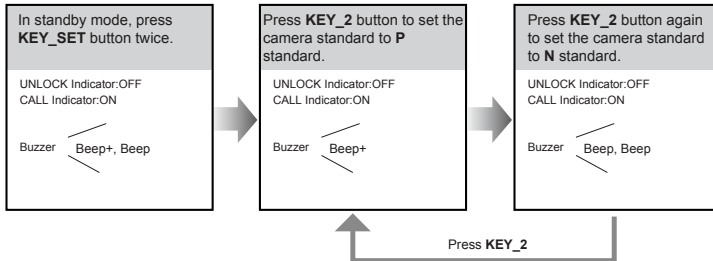

- If setting mode has not been exited, you can change the camera standard by pressing KEY2 circularly.
- The **LED_NAME** indicator will blink all the time until exit out the setting mode.
- If without any operation in 10 seconds, it will exit out setting mode automatically.
- In this step,press **KEY_SET** button three times to exit out the setting mode manually.

Setting Prompt Voice

Max. 9-languages voice to select, **No voice**, **Voice 1** and **Voice 2** ...

Voice 1 is default, to change the setting, please follow the steps:

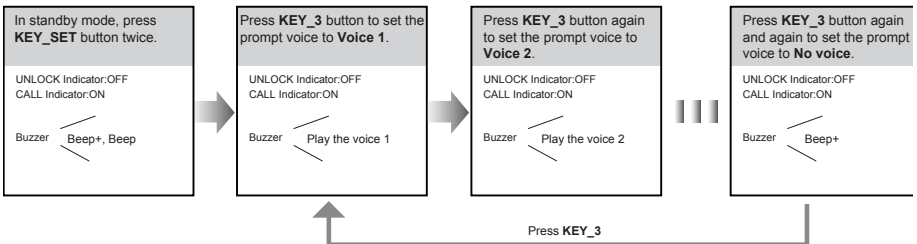

- If setting mode has not been exited, you can change the prompt voice by pressing KEY3 circularly.
- The **LED_NAME** indicator will blink all the time until exit out the setting mode.
- If without any operation in 10 seconds, it will exit out setting mode automatically.
- The voice can be customized.

SETUP INSTRUCTIONS

Setting Prompt Voice Volume

Total 9 level can be configured. It can be modified either before or after installation.

6 is default, to change the setting, please follow the steps:

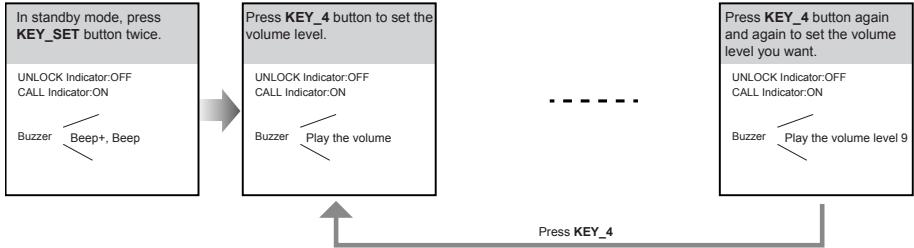

- If setting mode has not been exited, you can change the volume level by pressing KEY4 circularly.
- The **LED_NAME** indicator will blink all the time until exit out the setting mode.
- If without any operation in 10 seconds, it will exit out setting mode automatically.

Setting Unlock Mode

There are 2 unlock modes, **Normally opened** and **Normally closed**.

Normally opened is default, to change the setting, please follow the steps:

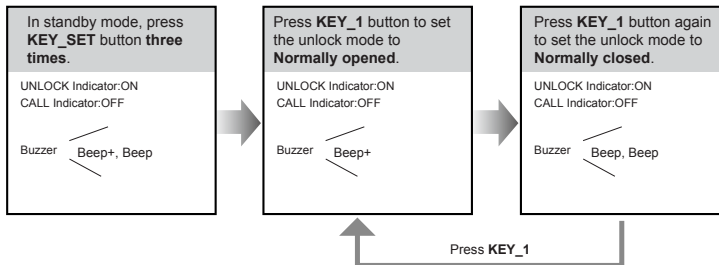

- If setting mode has not been exited, you can change the unlock mode by pressing KEY1 circularly.
- The **LED_NAME** indicator will blink all the time until exit out the setting mode.
- If without any operation in 10 seconds, it will exit out setting mode automatically.
- In this step, press **KEY_SET** button twice to exit out the setting mode manually.

SETUP INSTRUCTIONS

Setting Unlock Time

By default, the unlock time is 1s, but it can be changed, the setting range is 1s~99s.

Follow the steps:

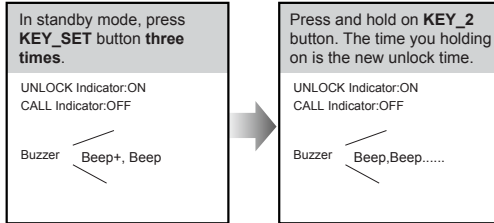

- When entering time delayed setting, the buzzer sound one time every second.
- The **LED_NAME** indicator will blink all the time until exit out the setting mode.
- If without any operation in 10 seconds, it will exit out setting mode automatically.
- In this step, press **KEY_SET** button twice to exit out the setting mode manually.

Setting Nameplate Illumination Mode

There are 3 illumination modes for nameplate indicator, **Normally on**, **Normally off** and **Auto**.

Normally on is default, to change the setting, please follow the steps:

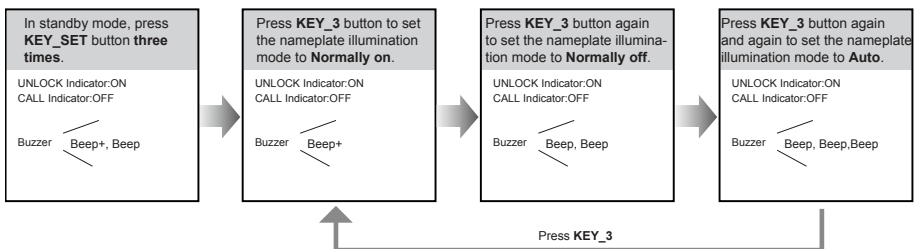

- If setting mode has not been exited, you can change the nameplate illumination mode by pressing **KEY3** circularly.
- The **LED_NAME** indicator will blink all the time until exit out the setting mode.
- If without any operation in 10 seconds, it will exit out setting mode automatically.
- In this step, press **KEY_SET** button twice to exit out the setting mode manually.

SETUP INSTRUCTIONS

Setting Night View LED Illumination Mode

There are 3 working modes for night view LED indicator, **Normally on**, **Normally off** and **Auto**. Auto is default, to change the setting, please follow the steps:

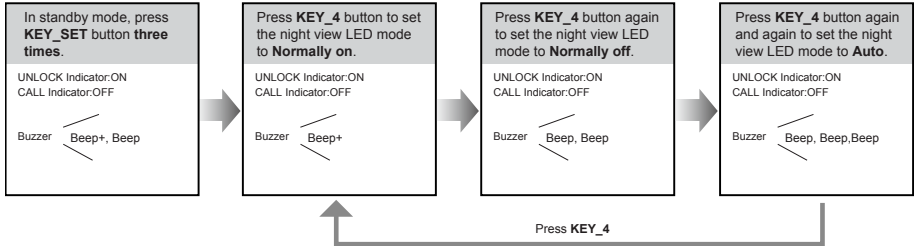

- If setting mode has not been exited, you can change the night view LED illumination mode by pressing KEY4 circularly.
- The **LED_NAME** indicator will blink all the time until exit out the setting mode.
- If without any operation in 10 seconds, it will exit out setting mode automatically.
- In this step, press **KEY_SET** button twice to exit out the setting mode manually.

Setting Ring-back Tone

If allow ring-back tone, press the call button to call monitor, a ring-back call tone can be heard from door station.

There are 3 ring-back call tones, **Ringing one time**, **Ringing continuously** and **No ring-back tone**.

Ringing one time is default, to change the setting, please follow the steps:

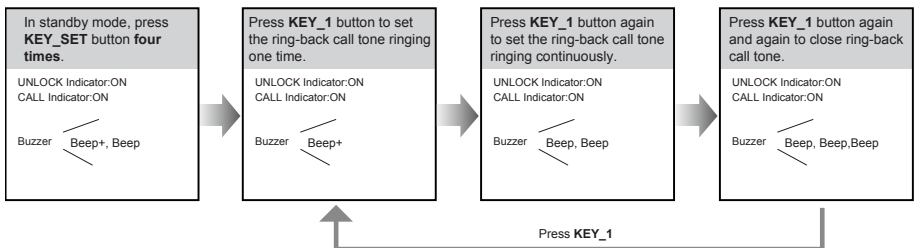

- If setting mode has not been exited, you can change the ring-back tone by pressing KEY1 circularly.
- The **LED_NAME** indicator will blink all the time until exit out the setting mode.
- If without any operation in 10 seconds, it will exit out setting mode automatically.
- In this step, press **KEY_SET** button once to exit out the setting mode manually.

SETUP INSTRUCTIONS

Setting Image Display Mode

Please know that this setting is only effective for monitors which does not support manual operation for pan-tilt.

When the monitor being called

When door station calls monitor,the image will be displayed on screen,there are 3 modes for image displayed, **Alternate switching mode**,**Zoom mode** and **Full screen mode**.

Alternate switching mode: when the monitor being called, switch at regular time(5s) between **Full screen** and **Zoom** image.

Zoom mode: when the monitor being called, the image will be displayed on full screen for 5 seconds, then switch to **Zoom** image.

Full screen mode: when the monitor being called, the image will be always displayed on **Full screen**.

Alternate switching mode is default, to change the setting, please follow the steps:

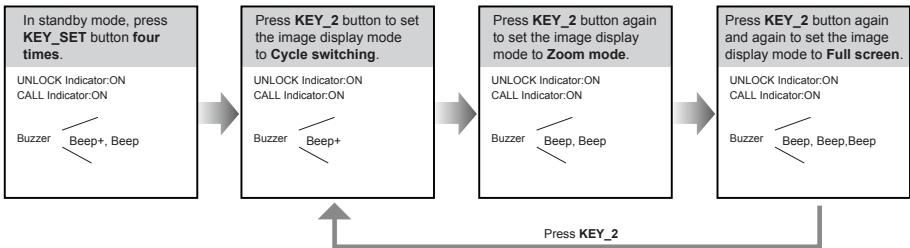

- If setting mode has not been exited, you can change the image display mode by pressing KEY2 circularly.
- The **LED_NAME** indicator will blink all the time until exit out the setting mode.
- If without any operation in 10 seconds, it will exit out setting mode automatically.
- In this step,press **KEY_SET** button once to exit out the setting mode manually.

When answering the call

When answering the call, the image switching reminder can be activated or forbidden.

If set to activated mode, the image switching reminder will be different for different image display mode.

Alternate switching mode: When answering the call, image switching reminder is not effective.

Zoom mode: When answering the call, the image will be displayed on **full screen** for 5 seconds, then switch to **Zoom** image to remind to enter talking status.

SETUP INSTRUCTIONS

Full screen mode: When answering the call, the image will be displayed on **Zoom** mode for 5 seconds, then switch to **Full screen** to remind to enter talking status.

If set to forbidden mode, there is no image switching reminder at any image display mode.

Activated is default, to change the setting, please follow the steps:

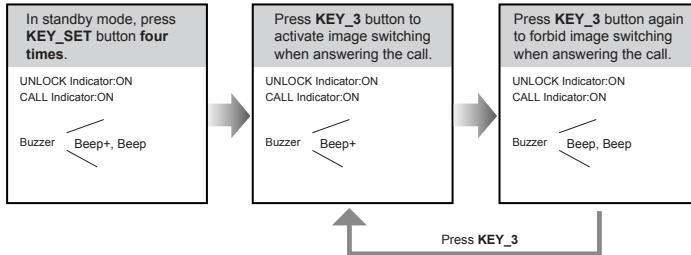

- If setting mode has not been exited, you can change the image display mode by pressing KEY3 circularly.
- The **LED_NAME** indicator will blink all the time until exit out the setting mode.
- If without any operation in 10 seconds, it will exit out setting mode automatically.
- In this step, press **KEY_SET** button once to exit out the setting mode manually.

RAINY_COVER Configure

It can be set the rainy cover mode.

Mounting the rainy cover is default, to change the setting, please follow the steps:

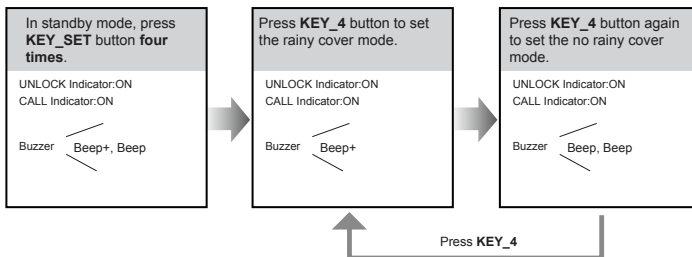

- If setting mode has not been exited, you can change rainy cover mode by pressing KEY4 circularly.
- The **LED_NAME** indicator will blink all the time until exit out the setting mode.
- If without any operation in 10 seconds, it will exit out setting mode automatically.
- In this step, press **KEY_SET** button once to exit out the setting mode manually.

SETUP INSTRUCTIONS

Registering ID Card

- Up to 320 user cards can be registered by the door station.
- Easy management with LED status and sound hints.
- There are two master cards, one **MASTER CARD ADD** card and one **MASTER CARD DELETE** card, When registered new master cards, the old master cards are invalid automatically.
- Card reading distance is less than 3cm.
- The master cards are necessary when you add or delete user cards. Please keep it well for future use.
- EM card, 125kHz.

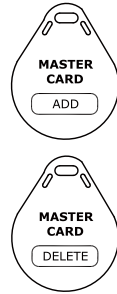

Authorizing master cards:

By default, there are two master cards marked **MASTER CARD ADD** and **MASTER CARD DELETE**, but you should know that the master card can be authorized by users at any time. That means any two user cards can be authorized to master cards, When registered new master cards, the old master cards will be invalid automatically.

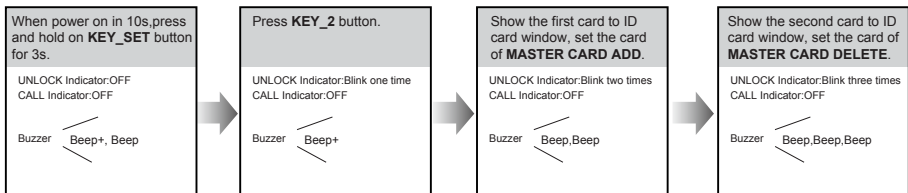

- The **LED_NAME** indicator will blink twice per second until exit out the master card authorized mode.
- If without any operation in 10 seconds, it will exit out setting mode automatically.
- It will exit out setting mode automatically after showing these two cards, the UNLOCK&CALL indicator will be turned off.

SETUP INSTRUCTIONS

Switching Access Control:

The access can be controlled by door station or DT-ACC,so it's available to switch the access function.

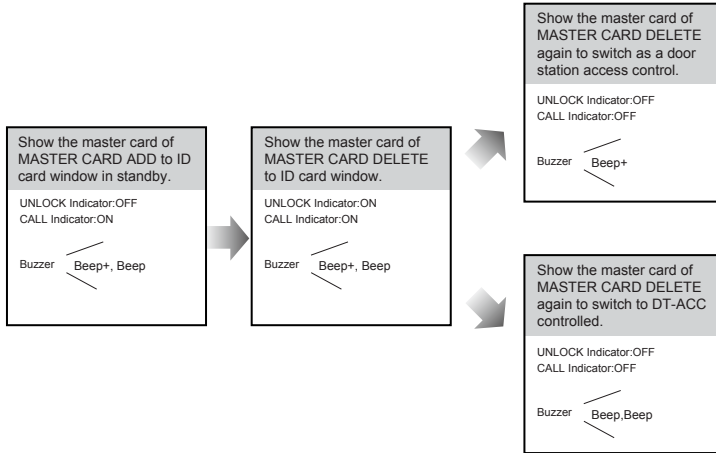

- If without any operation in 10 seconds, it will exit out setting mode automatically.
- If current access is controlled by door station, next access switching setting is controlled by DT-ACC.

Adding User Cards:

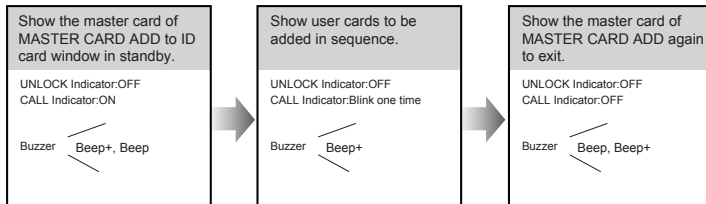

- If without any operation in 10 seconds, it will exit out setting mode automatically.
- To add user card, the access must be controlled by door station.

SETUP INSTRUCTIONS

Deleting User Cards:

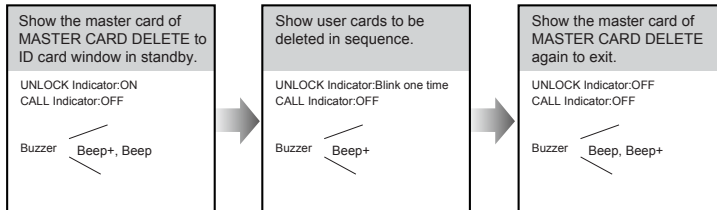

- If without any operation in 10 seconds, it will exit out setting mode automatically.
- To add user card, the access must be controlled by door station.

Initializing Access (delete all user cards):

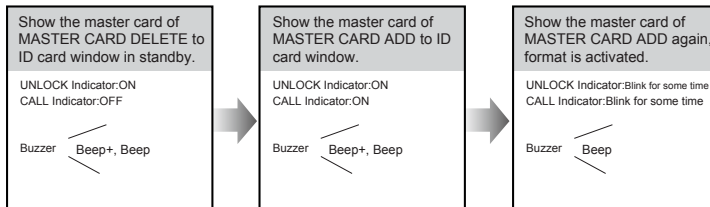

- If without any operation in 10 seconds, it will exit out setting mode automatically.
- To add user card, the access must be controlled by door station.
- At step3, the UNLOCK & CALL indicator will blink all time until formatting is finished.
- When formatting is finished, UNLOCK & CALL indicator will be turned off and sound " Beep+ ", and exit out setting mode automatically.

Restore To Default

The restore to default function allows the user to recover the settings to factory setting.

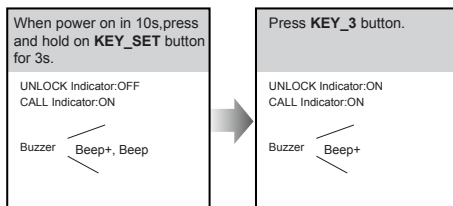

- The LED_NAME indicator will blink twice per second until exit out the restore to default mode.
- If without any operation in 10 seconds, it will exit out setting mode automatically.
- When restoring is finished, UNLOCK & CALL indicator will be turned off, and exit out setting mode automatically.

WIRING

Connecting Electric Lock

Door Lock Controlled with Internal Power

1. Electronic lock of Power-on-to-unlock type should be used.
2. The door lock is limited to 12V, and holding current must be less than 250mA.
3. The jumper should be placed on position 2 and 3 before connecting.
4. The door lock control is not timed from Exit Button(EB).
5. The **Unlock Mode** must be set to 0 (by default).

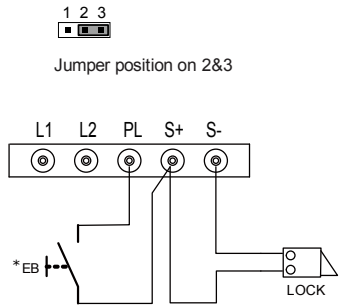

Door Lock Controlled with Dry Contact

1. The external power supply must be used according to the lock.
2. The inside relay contact is restricted to 230Vac 1A or 24Vdc 1A.
3. The jumper must be taken off before connecting.
4. Setup the **Unlock Mode** according to different lock types.
 - Power-on-to-unlock type: Unlock Mode=0 (by default)
 - Power-off-to-unlock type: Unlock Mode=1

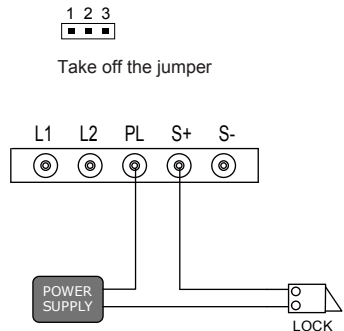

* DT-RLC relay actuator is needed for 2nd lock connection.

As The Villa System Door Stations

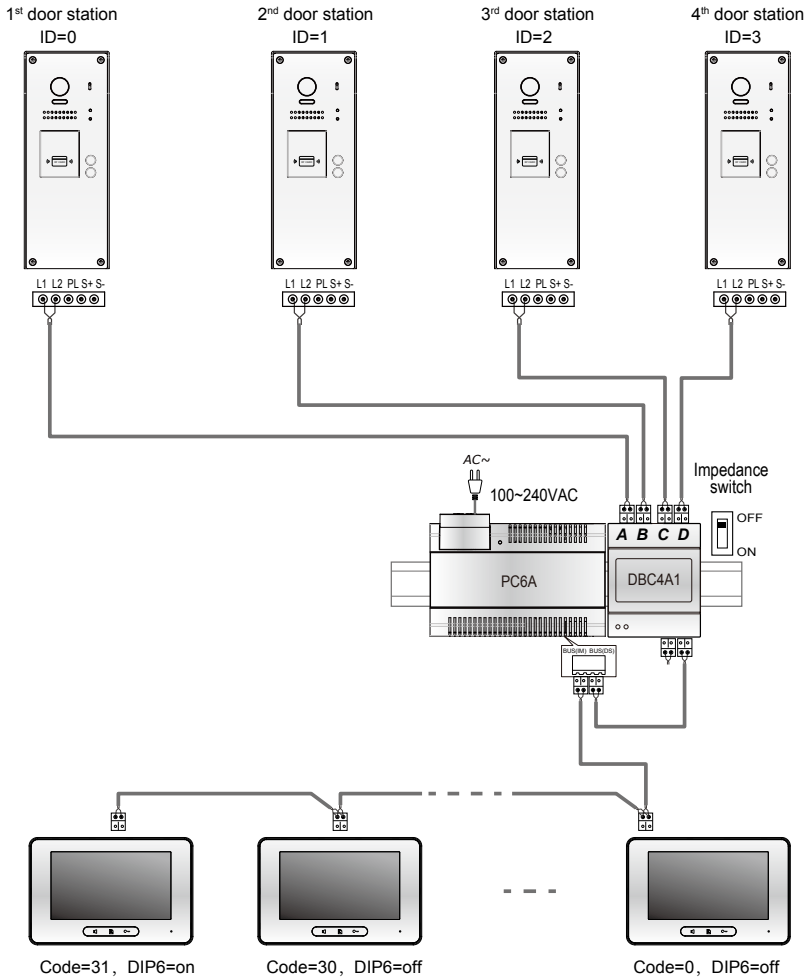

- Door stations were configured as the villa system door stations.
- Max.4 door stations can be connected to the system.
- Ensure to set the correct address for each door station, Refer to Page 8 for more details about the address setting of door stations.

APPENDIX

Precautions

- Please clean the unit with soft cotton cloth, don't use the organic impregnant or chemical clean agent. If necessary, please use a little pure water or dilute soap water to clean the dust.
- The unit is weather resistant. However do not spray high pressure water on access control keypad directly. Excessive moisture may cause problems with the unit.
- You must use the right adaptor which is supplied by the manufacture or approved by the manufacture.
- Pay attention to the high voltage inside the products, please refer service only to a trained and qualified professional.

Specification

- Power Supply : DC 24V;
- Power Consumption: Standby 1.2W; Working status 4.8W;
- Fish Camera: Color CMOS, 2.0 Mega pixel 1/2.7''
fisheye camera,170° wide angle(DT608);
- 3089 Camera: Color CMOS, 520TVL , 1/4'' camera,
105° wide angle (DT608C);
- Lock Power supply: 12Vdc, 250mA(Internal Power);
- Unlock time: 1~99s(Default 1s);
- Number of relay circuits: 2 (the second lock need external
device to support);
- Working temperature: -20°C ~ +55°C;
- Wiring: 2 wires,non-polarity;
- Protection: IP45;
- Dimension: 281(H)×110(W)×44(D)mm.

APPENDIX

Cables and Requirments

The maximum distance of the wiring is limited in the DT system. Using different cables may also affect the maximum distance which the system can reach.

Basic IN-OUT Wiring Mode

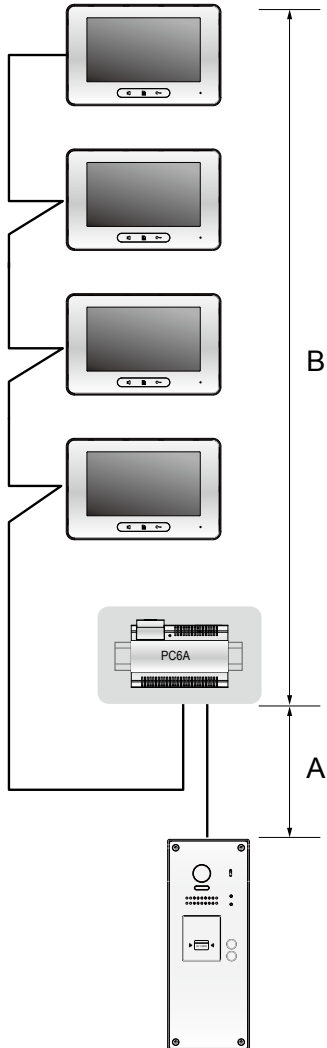

Cable and distance(unit:m)

Cable Usage	A	B	B
		≤2 IM	≤16 IM
Twisted cable 2x0.75mm ²	60	100	40
Twisted cable 2x1mm ²	80	120	60

APPENDIX

Star Topology Wiring Mode With DBC4A1

