

2-wire Intercom System

CONTENTS

Installation Guide.....2

Modules.....4

 Camera Module.....4

 Keypad Module.....6

 TFT Module.....11

 Card Reader Module.....12

 Call Button Module14

Module Connection.....16

CONFIGURATIONS.....19

 Common Door Station Setting19

 Software Update20

 Tone Update20

 Namelist Update21



DMR21/S8



DMR21/D16



DMR21/S4/F1



DMR21/D8/F1



DMR21/F2

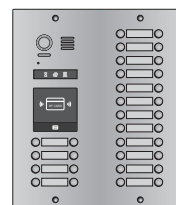

DMR21/D32/F1



EP21/F3



EP21/S12

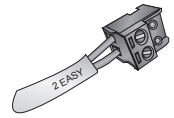

DESCRIPTION

The door stations are used as speaking and operating units for the door communication system at the front door. Via the door station, a call is connected to the desired home station after a call button is pressed.

The DMR21 with the modular design ensures a high level of flexibility, for example, the video entry module and the card reader module can be assembled with call buttons outdoor station and the user can swipe cards to open the door. For such combination, about the card configurations, please refer to DT system technical guide.

The keypad module can be assembled with call buttons outdoor station, and users can enter the password to open the door, about the keypad configurations, please refer to DT system technical guide.

PARTS AND FUNCTIONS

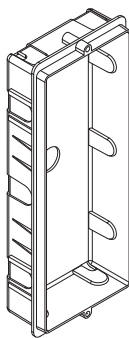
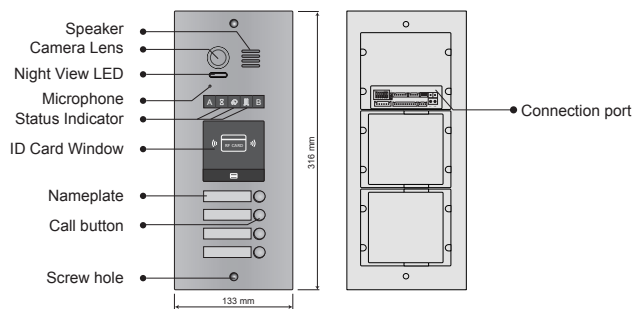

Embedded box

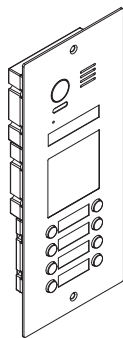

Stainless steel panel

Note: Key A and key B will not be seen on the panel, they are cryptic. Normally, key A and key B are not activated, about the keys activated, refer to the section of MODULES -> CAMERA MODULE.

TERMINAL

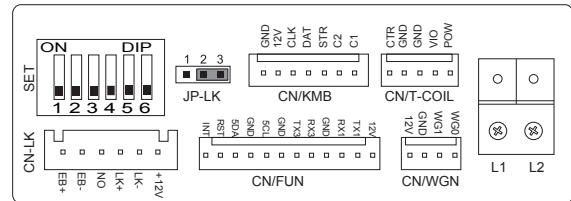

- **+12V:** 12VDC power output.
- **LK-:** Power ground.
- **LK+:** Common contact of the relay.
- **NO.:** Normally open contact of the relay (refer to DT technical guide for Lock connection detail informations).
- **EB+:** Exit button positive connection port.
- **EB-:** Exit button negative connection port.
- **JP-LK:** For electronic lock safety type setting (refer to door lock connections).
- **SET :** DIP switches for system configurations.
- **CN/KMB:** Call button module connection port.
- **CN/T-COIL:** Reserved.
- **CN/FUN:** Touch sensor keypad module or TFT display module connection port.
- **CN/WGN:** Card reader module connection port.
- **Bus(L1,L2):** Non-polarity bus line, connect to PC6 (power comb unit).

PLACE NAMEPLATE

Press down and move right/left to open the transparent nameplate cover. The insert the name paper and put the cover back. Note that the double row button panel can be opened both direction, single row button can only be opened at right side.

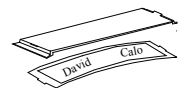
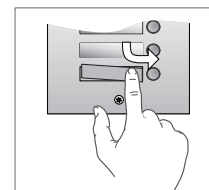
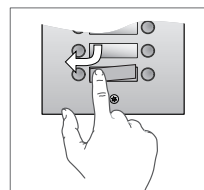

name paper

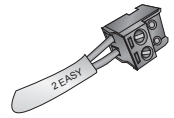

MOUNTING

Standard mounting

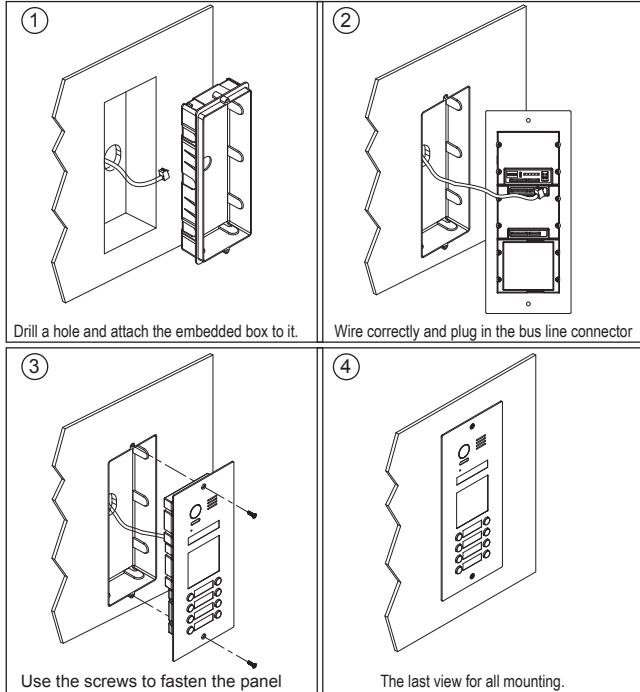

Mounting with expanding panel

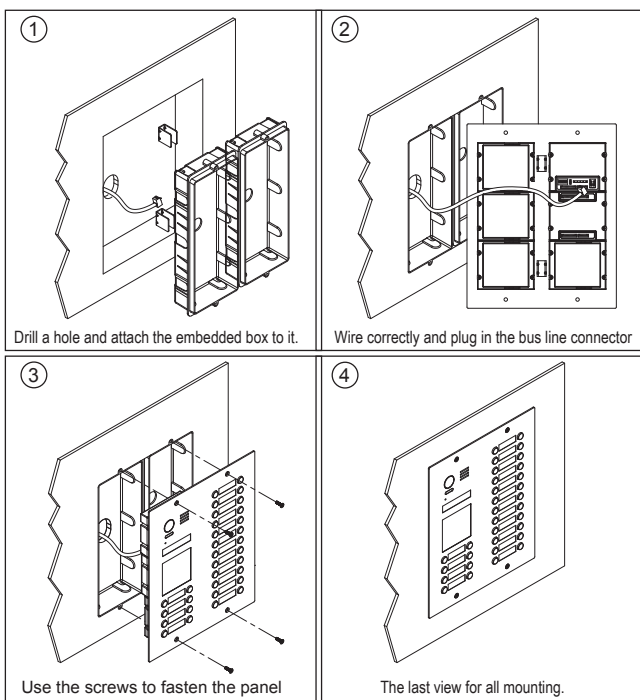

SYSTEM CONNECTION

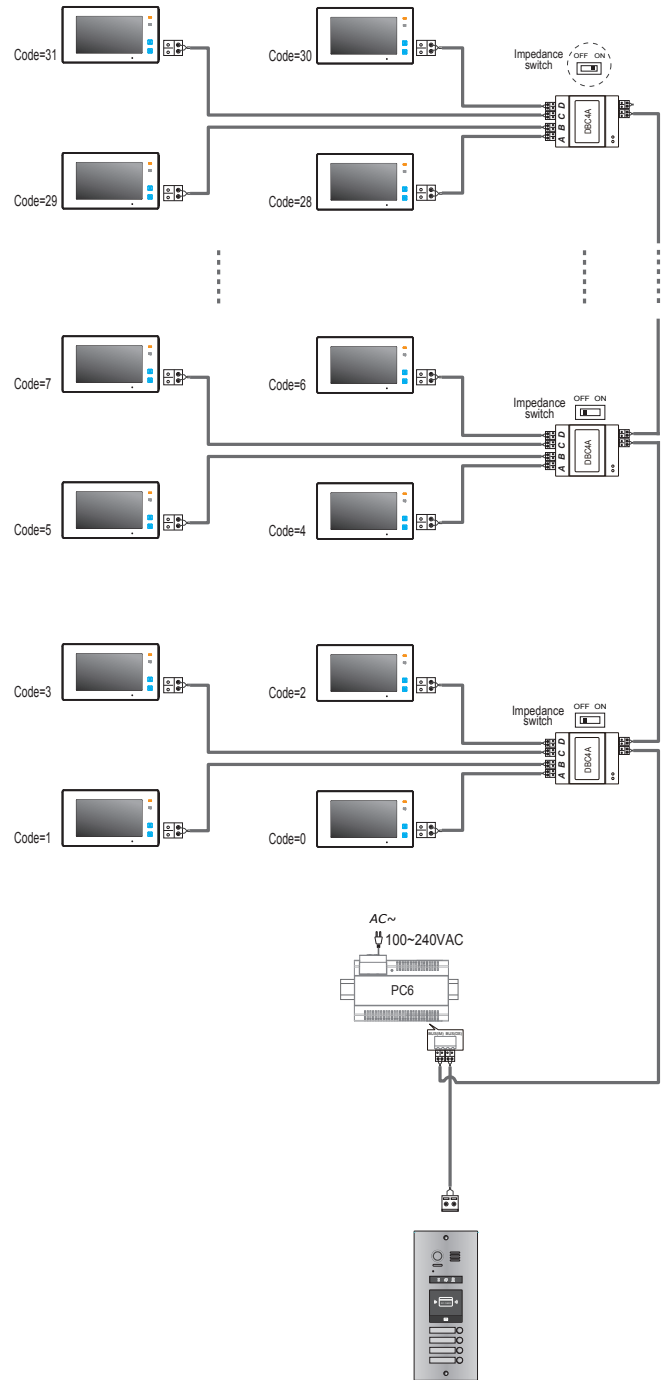

• Note: the sketch map is taken DT47M monitor for example.

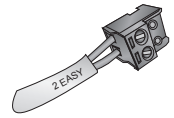

DIP SWITCHES SETTING

Totally 6 bits can be configured by dip-switch. The switches can be modified either before or after installation, but restarting the power is needed whenever the switches have been modified.

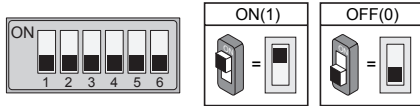

Bit-1 and Bit 2 is for door station ID settings. When multi door stations are installed in the system, these two bit must be set correctly, the first door station set to 00, the second one set to 01, the third one set to 10, the fourth one set to 11. If only one door station is installed, set to 00.

Bit-3 is for single or double row button door station selection. If the door station is a double row button, such as DMR21-D8, set this bit to 0. For single row button door station, set to 1.

Bit-4 is for button code selection. If use the default codes for each button of the door station, set to 0. If use the programmed codes, set to 1.(the code for each button can be programmed by software, detail information refer to DT system technical guide)

Bit-5 is for unlocking time quick setting. 0 is the default setting, and the default time is 1 second. If set to 1, the unlock time is 5 seconds(the unlock time can be modified by door station or software)

Bit-6 is for activating the key A and key B. Normally key A and key B is not activated(about the functions of key A and key B, please refer to DT system technical guide), Just when it set to 1, the key A and key B is activated.

ELECTRIC LOCK CONNECTION

1) Door Lock Controlled with Internal Power

1. The door lock is limited to 12Vdc, and holding current must be less than 250mA when using internal power supply mode.
2. The Unlock Mode Parameter must be set to 0 (by default).
3. Jumper set to 1-2 position for power-off-to-unlock safety type(*Normally closed mode*); set to 2-3 position for power-on-to-unlock type(*Normally open mode*).
4. If different unlocking time is needed to be configured, change the unlock time on door station, detail information refer to DT system technical guide .

Power-on-to-Unlock type:

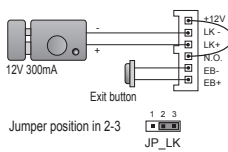

Power-off-to-Unlock type:

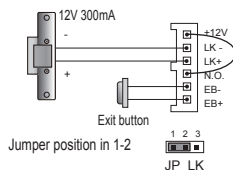

2) Door Lock Controlled with External Power

1. The external power supply must be used according to the lock.
2. The jumper must be taken off before connecting.
3. Setup the **Unlock Mode Parameter** for different lock types
 - Power-on-to-unlock type: Unlock Mode=0 (by default)
 - Power-off-to-unlock type: Unlock Mode=1
4. If different unlocking time is needed to be configured, change the unlock time on door station, more detail information refer to DT system technical guide .

Power-on-to-Unlock type:

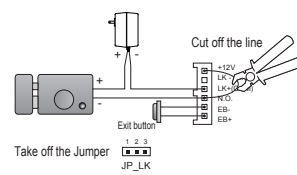

Power-off-to-Unlock type:

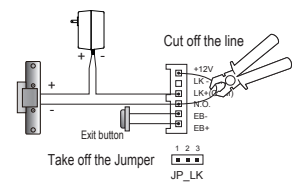

SPECIFICATION

- Power supply: 26Vdc (supplied by PC6)
- Power Consumption: 1W in standby, 5W in working
- Unlock Power output: 12Vdc, 250mA
- Unlock timing: 1~99s
- Working temperature: -20°C ~ +55°C
- Dimension: 316(H)x133(W)x48(D)mm

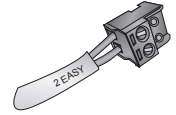

CAMERA MODULE

1. Parts and functions

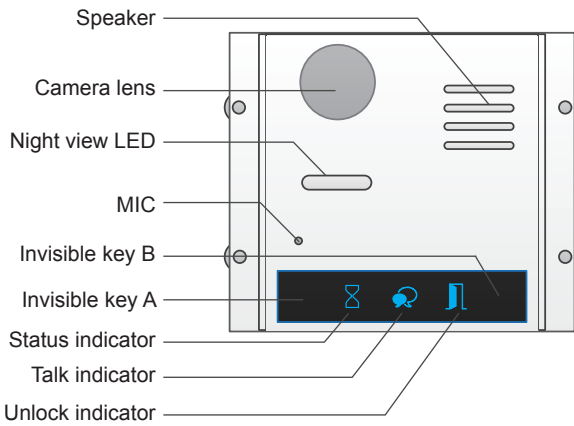

Note: Key A and key B can not be seen on the panel, they are cryptic. Normally, key A and key B are not activated. **To activate the buttons, just set the DIP6 to ON.**

2. Settings via touch button

Please know that the DIP6 switch must be set to ON while the others are set to OFF to carry on the following settings.

• **Unlocking Mode Setting**

When the door station with **Camera Module** is in standby.

(1) Press Key A, the **Unlock indicator** turns on with the warning sound of BP+, BP;

(2) Press Key A again to set the **Unlocking Mode to Normally On or Normally Closed.** (**Normally On:** the **Status indicator** blinks for one time with the warning sound of BP+; **Normally Closed:** the **Status indicator** blinks for twice with the warning sound of BP+, BP).

If **TFT Module** is connected, the info will be displayed on screen.



• **Unlocking Time Delay Setting**

When the door station with **Camera Module** is in standby.

(1) Press Key A, the **Unlock indicator** turns on with the warning sound of BP+, BP;

(2) Press Key B and hold on to enter the **Unlocking Time Delay Setting**, a warning sound of BP will be heard and the **Status indicator** blinks one time per second.

The counting of **Unlocking Time** is the times that **Status indicator** blinks (the unit is second). For example, the **Status indicator** blinks for four times, that means the unlocking time is 4 seconds.



• **Warning Tune Setting**

When the door station with **Camera Module** is in standby.

(1) Press Key A and hold on for 3 seconds to enter the **Warning Tune Option Mode**, the **Status indicator** turns on and the current tune is playing;

(2) Press Key A again to play next tune;

(3) Press Key B to quit.



• **Tune Volume Setting**

When the door station with **Camera Module** is in standby.

(1) Press Key B to enter **Tune Volume Setting**, the **Talk indicator** turns on, at the same time, play the tune at current volume;

(2) Press Key A to increase/decrease the volume;

(3) Press B to exit.

If **TFT Module** is connected, the current **Volume** will be displayed on screen.



• **Talk Volume Setting**

(1) During conversation, press Key B and hold on for 3 seconds to enter the **Talk Volume Setting**, The **Talk indicator** turns on with the warning sound of BP+, BP;

(2) Press Key A to increase/decrease the volume.

(3) Press Key B to exit.

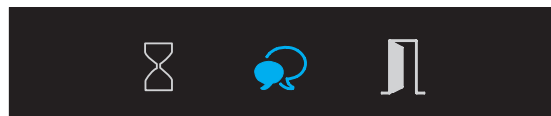

3. Restore factory setting

Attention: All settings will be canceled if the **Restore Factory Setting** is activated. Include the modules setting, such as ID module, Touch Keypad module...etc. Even if the modules are not connected to the **Camera Module**.

When in standby mode. Short out the **Exit Button Port (EB+, EB-)**, then continuously toggle the DIP6 switch for 4 times with a warning sound of BP+, and the three Indicators will blink at the same time, that means the **Restore Factory Setting** is in progress; If the three Indicators turn off with a warning sound of BP+, it means the **Restore Factory Setting** is finished.

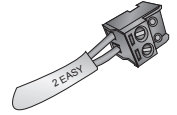

KEYPAD MODULE

1. Parts and functions

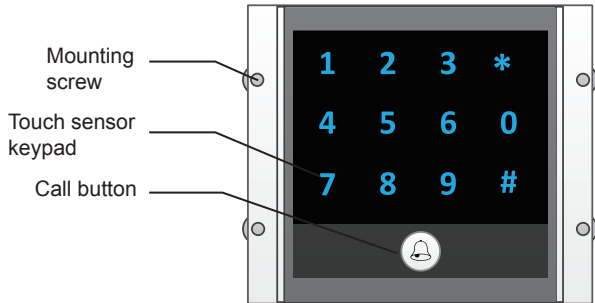

2. Keypad operation with TFT module

• Call Residents

Input room number directly, the screen will be showed the room number,press to start calling.

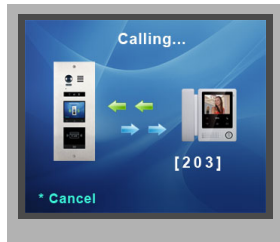
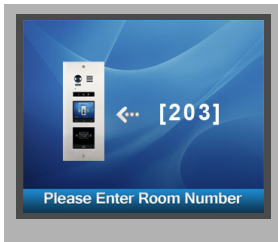

• Password Unlocking

Input password +"#*" to unlock the door.



• Parameters Setting

This section explains the settings of each function, please refer to the following table:

About the setting mode:

Input the master code to switch to the setting mode, and input the corresponding setting code to perform the settings for the function you want. After settings have been made, input the following setting codes to continue the setting operation. Press "*" to exit the setting mode.



- The example is set * as cancel button and # as confirm button,please refer to */# function setting for detail information.
- Forbid to slide to touch the digital keypad,it may cause mistaken key,the correct operation is using your finger to press the digital you desired.
- You should press"confirm"button after finish inputting the code number each time,otherwise,the operation will be cancelled automatically in 10s.

Setting items	Setting range	Default value	Setting code
Reset all settings	1,2,3,4	-	00
Setting the master code	1 ~ 12 digits Valid keys:0 ~ 9	1234	01
Setting the key illumination time	10 to 99 seconds/ continually lit	10 seconds	02
Setting the unlock time	01 to 99 seconds	1 seconds	03
Setting the unlock mode	0:opened/1:closed	opened	04
Operation tone settings	0,1,2	on	05
Reset code settings	1,2,3,4	-	06
*&# function settings	0:Normal/1:Reverse	Normal	07
Call tone settings	0:Enable/1:Disable	Enable	08
Interference resistant grade settings	Valid keys:0 ~ 5	2	09
SPK Adjustment	Valid keys:0~9	5	11
Night light level	Valid keys:0 ~ 5	4	13
Reserve	Reserve	Reserve	14~17
Setting the code forTemporary1	1 ~ 12 digits Valid keys:0~9	-	18
Setting the code forTemporary2	1 ~ 12 digits Valid keys:0~9	-	19
Setting the code for user group1	1 ~ 12 digits Number of codes:40 Valid keys:0~9	-	20~59
Setting the code for user group2	1 ~ 12 digits Number of codes:40 Valid keys:0~9	-	60~99

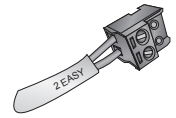

Input the master code.
(Default: [1 2 3 4] +[#])

Beep+, Beep

1.Reset all settings 2.Setting the master code (Default : 1234) 3.Setting the key illumination time (Default : 10s) 4.Setting the unlock time (Default : 1s)

Input the setting code.
00+#

Beep+, Beep

Input the setting code.
01+#

Beep+, Beep

Input the setting code.
02+#

Beep+, Beep

Input the setting code.
03+#

Beep+, Beep

Inputting of code
1234+#

Beep+

Inputting of new master code
(ex.: 4321)(1~12 digits)
4321+#

Beep+

Inputting of code (ex.: 10)
range:00 or 10~99
10+#

Beep+

Inputting of code (ex.: 09)
range:01~99
09+#

Beep+

- When the “ * cancel!” key is pressed, the indicator will show its standby color, the buzzer beeps, and the system exits the setting mode.
- When there isn't any operation in 10s, the buzzer beeps, and the system exits the setting mode.
- When setting failure, the buzzer beeps.

Beep, Beep+

- All settings will restore to their default value.
- When power on or activate the reset all setting item, the keypad checking will carry out, during this time, the key illumination will blink and the touching operation is forbidden, after finish checking, the key illumination will stop blinking and sent out a long sound of beep

- The master code is allowed 1~12 digits, the same code cannot be set for both the user code and the master code, it is recommended that you modify the default master code.

- If the key illumination time is set to 00, the key illumination will light up all the time when power on.
- If the key illumination time is set to 10~99, the key illumination will light up for 10~99 seconds. At this mode, the key illumination lights off in standby mode, touching any digital key can illuminate, but this is the invalid digital.

- The unlock time can be set on both monitor and door station, and the valid value is the number you set last time.

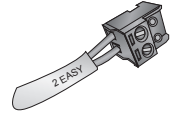

Input the master code.
(Default: [1 2 3 4] +[#])

Beep+, Beep

5. Setting the unlock mode (Default : 0(opened)) **6. Setting operation tone (Default : ON)** **7. Reset code setting** **8. * & # function setting (Default : Normal)**

Input the setting code.
04+#

Beep+, Beep

Input the setting code.
05+#

Beep+, Beep

Input the setting code.
06+#

Beep+, Beep

Input the setting code.
07+#

Beep+, Beep

0/1
Inputting of code (ex.: 1)
range:0:(open)/1:(close)
1+#

Beep+

0/1
Inputting of code (ex.: 1)
range:0:(on)/1:(off)
1+#

Beep+

Inputting of code
1234+#

Beep+

0/1
Inputting of code (ex.: 1)
range:0:(normal)/1:(reverse)
1+#

Beep+

- When the “ * cancel” key is pressed, the indicator will show its standby color, the buzzer beeps, and the system exits the setting mode.
- When there isn't any operation in 10s, the buzzer beeps, and the system exits the setting mode.
- When setting failure, the buzzer beeps.

Beep, Beep+

- The unlock mode can be set on both monitor and door station, and the valid value is the number you set last time.

- When the operation tone is set to 0, pressing the digital keypad will sent out a sound of beep.
- When the operation tone is set to 1, pressing the digital keypad will blink one time.

- Cancel all the passwords except the master code.
- Restore the master code to default value(1,2,3,4)

- When the item is set to 0, press the * button to cancel the input, and press the # button to confirm the input.
- When the item is set to 1, press the # button to cancel the input, and press the * button to confirm the input .

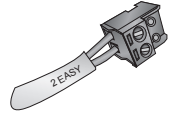

Input the master code.
(Default: [1 2 3 4]+[#])

Beep+, Beep

9. Call tone setting (Default : enable) 10. Interference resistant grade setting (Default : 2) 11. SPK volume adjust setting (Default:4) 12. Night light level setting (Default : 4)

Input the setting code.
08+#

Beep+, Beep

Input the setting code.
09+#

Beep+, Beep

Input the setting code.
11+#

Beep+, Beep

Input the setting code.
13+#

Beep+, Beep

0/1
Inputting of code (ex.: 1)
range:0(enable)/1:(disable)
1+#

Beep+

Inputting of code (ex.: 3)
range:0~5
3+#

Beep+

Inputting of code (ex.: 5)
range:0~9
5+#

Beep+

Inputting of code (ex.: 3)
range:0~5
3+#

Beep+

- When the “ * cancel” key is pressed, the indicator will show its standby color, the buzzer beeps, and the system exits the setting mode.
- When there isn't any operation in 10s, the buzzer beeps, and the system exits the setting mode.
- When setting failure, the buzzer beeps.

Beep, Beep+

- If the item is set to 0, the unit will respond a call tone when pressing the “CALL” button.
- If the item is set to 1, the unit will have no responds when pressing the “CALL” button.

- The larger you set the interference resistant grade, the stronger it will be, but the sensitivity of the keypad will be more lower.
- The interference resistant grade setting also will activate the keypad checking.

- Unlock via password is still available even when the door station is talking.
- When door station is talking, you can enter the Master code (the LED turns white upon that) to activate the volume adjusting function:
* Speaker adjustment: 3 (up), 6 (down)

- Night Light Level:0~5.
-The higher the number, the brighter the night lights.

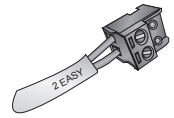

Input the master code.
(Default: [1 2 3 4]+[#])

Beep+, Beep

16. Setting the code for Temporary1 17. Setting the code for Temporary2 18. Setting the code for user group1 19. Setting the code for user group2

<p>Input the setting code. 18+#</p> <p style="text-align: right;">Beep+, Beep</p>	<p>Input the setting code. 19+#</p> <p style="text-align: right;">Beep+, Beep</p>	<p>20~59 Input the setting code. (ex.:21) 21+#</p> <p style="text-align: right;">Beep+, Beep</p>	<p>60~99 Input the setting code. (ex.:60) 60+#</p> <p style="text-align: right;">Beep+, Beep</p>
--	--	---	---

<p>Inputting of code (ex.: 1006) 1~12 digits 1006+#</p> <p style="text-align: right;">Beep+</p>	<p>Inputting of code (ex.: 2011) 1~12 digits 2010+#</p> <p style="text-align: right;">Beep+</p>	<p>Inputting of code (ex.: 2011) 1~12 digits 2011+#</p> <p style="text-align: right;">Beep+</p>	<p>Inputting of code (ex.: 2012) 1~12 digits 2012+#</p> <p style="text-align: right;">Beep</p>
--	--	--	---

- When the “ * cancel” key is pressed, the indicator will show its standby color, the buzzer beeps, and the system exits the setting mode.

- When there isn't any operation in 10s, the buzzer beeps, and the system exits the setting mode.

- When setting failure, the buzzer beeps.

Beep, Beep+

- When input the correct temporary password to release the door, the system will clear the temporary password after 60 seconds automatically. But you should know that the password is valid within 60 seconds after inputting the correct temporary password
- The temporary1 is used to release the first lock, and the temporary 2 is used to release the second lock (the second lock need external device to support).
- If the password length exceeds 12 digits, the system will sent out the sound of “beep,beep,beep,beep”, and the digitals you input before will be cleared at the same time.
- The temporary code can not be set the same as the master code

- The user code group1 is used to release the first lock, and the user code group2 is used to release the second lock (the second lock need external device to support).
- The user code group1 and user code code group2 can contain 40 group passwords
- If the password length exceeds 12 digits, the system will sent out the sound of “beep,beep,beep,beep”, and the digitals you input before will be cleared at the same time.
- The user code can not be set the same as the master code and temporary code.

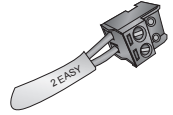

TFT DISPLAY MODULE

1. Parts and functions

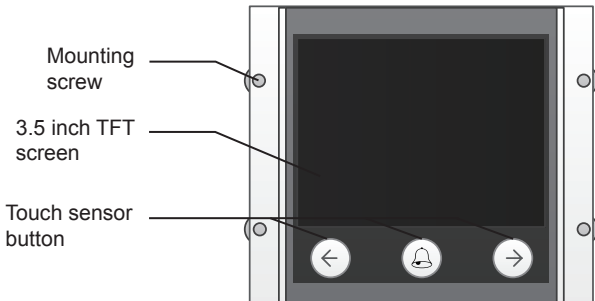

2. Features

- Calling via name list
- 3.5 inch TFT display
- Operation visualization
- With three touch button
- Easy update to name list or UI

3. Functions

• Standby

This is the start point in standby mode, It can be customized.(More details refer to UI Update section)

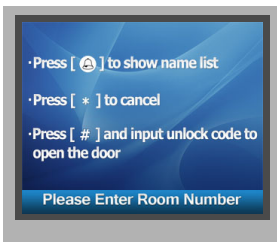

• Name List Calling

In standby mode, press to show the name list. Press or to select name. After that, press to call the corresponding user.

Press * (Keypad Module) to cancel the call.

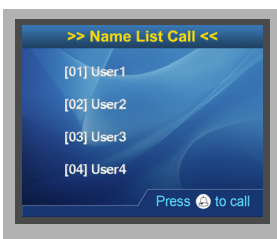

• Calling Display

This is the user interface of calling process. (Know that if the name list is created, the resident's name will be showed on screen)

Press * (Keypad Module) to cancel the call.



• Conversation

This is the user interface of conversation process.

The conversation time will be recorded.

Press * (Keypad Module) to cancel the call.

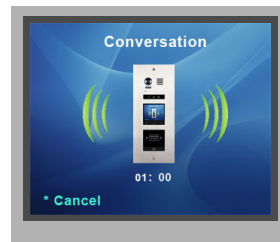

• Keypad operation

i) When in standby mode, input the number by pressing keypad, the room number will be showed on screen.



ii) When in standby mode, press # key, a password will be asked. This is the user interface of password input.



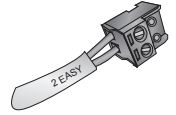

iii) When input admin code, a **Setting Code** will be asked on TFT screen.

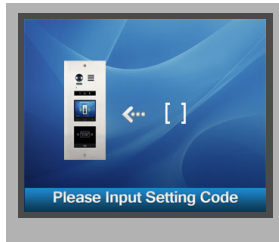

• **Combin with ID module**

This is the user interface when the right card has been read. the info of "Door1 open" will be showed screen.

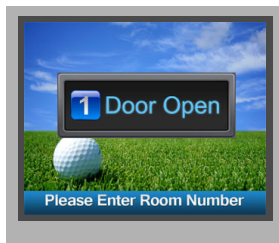

This is the user interface of adding card, please know that the user interface of delete card or initialization is similar as the following picture shows.

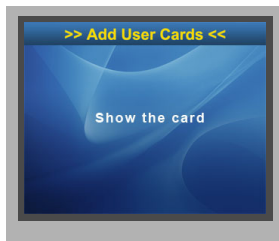

CARD READER MODULE

1. Parts and functions

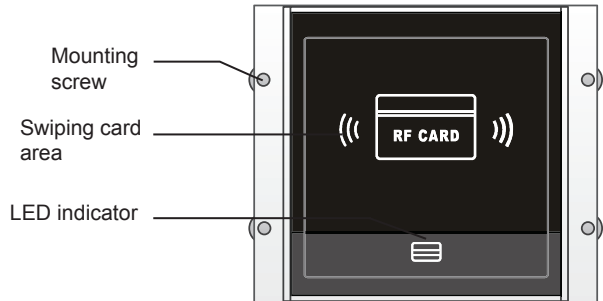

2. Features

- Up to 320 user cards can be registered by door station
- Easy management with indicators and sound hints
- Two **Master Cards** are available, one is MASTER CARD ADD and the other is MASTER CARD DELETE, when the new **Master Cards** registered, the old ones are invalid automatically
- The distance of card reading is from 3 to 5 cm
- The **Master Cards** are necessary when you add or delete user cards. Please keep it well for future use

3. Card Operation

• **Master Card Setting**

Power on and short out EB+,EB- , a sound of "BP+" will be sent out, and the **Unlock indicator** is turned on.



Toggle DIP4 switch for four times, a sound of "BP+,BP" will be sent out, the **Talk indicator** and the **Unlock indicator** will be turned on.



Show the **ADD CARD**, a sound of "BP+" will be sent out, the **Unlock indicator** is turned on.



Show the **DELETE CARD**, a sound of "BP+" will be sent out, and all indicators will be turned off. After 10 seconds, it will exit out the **Master Card Setting** automatically.

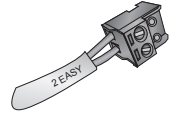

• **User Card Setting**

Power on and short out EB+,EB- , a sound of “BP+” will be sent out, and the **Unlock indicator** is turned on.



i) Add User Card

In standby mode, show the **MASTER CARD ADD**, it will sound “BP+,BP”, the **Talk indicator** is turned on.



Input the room number you need to set (0 is default). Show **User Cards**, it will sound “BP+”, and the **Talk indicator** blinks one time. (You can continuously show **User Cards**).



Show the **MASTER CARD ADD** to exit out Add User Card Setting, it will sound “BP,BP+”, and all indicators are turned off. (without any operation for 10 seconds, it will return to standby mode)

ii) Delete User Card

In standby mode, show the **MASTER CARD DELETE**, it will sound “BP+,BP”, and the **Unlock indicator** is turned on. and the **Delete Card Mode** is activated.

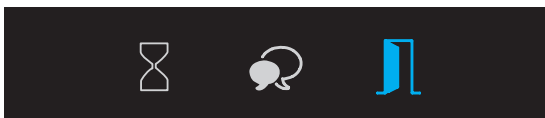

In Delete Card Mode :

--**Delete by room number:** Input the room code, it will sound “BP+”, and the **Unlock indicator** blinks one time,all associated cards will be deleted..

--**Delete by User Card:** Show the **User Cards** which you need to delete. It will sound “BP+”, and the **Unlock indicator** blinks one time. (You can continuously show user cards that you need to delete)

Show the **MASTER CARD DELETE** to exit out **Delete Card Mode**. It will sound “BP,BP+”, and all indicators are turned off. (without any operation for 10 seconds, it will return to standby mode)

iii) Format Card

In standby mode, show the **MASTER CARD DELETE**, it will sound “BP+,BP”, and the **Unlock indicator** is turned on.



Show the **MASTER CARD ADD**, it will sound “BP+,BP”, and the **Talk indicator** and the **Unlock indicator** are turned on.



Show the **MASTER CARD ADD**, it will sound “BP”, the **Talk indicator** and the **Unlock indicator** will blink, and after 10 seconds, it will return to standby mode and the format is finished.

iiii) Card Database

- i) By PC
- ii) By SD Card

4. Combination

• **Combin With TFT Module**



The informations will be displayed on screen when some operations are carried on, such as **Master Card Setting, Add User Card and Delete User Card** etc.

For example,swipe the user card, the info of “Door Open” will be displayed on screen.

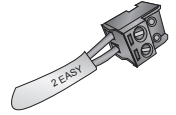

• **Combin With Keypad Module**



- 1) Master Card Setting(Reserve)
- 2) Add Card Setting(Reserve)
- 2) Delete Card Setting(Reserve)

• **Combin With Keypad & TFT Module**



CALL BUTTON MODULE

1. Parts and functions

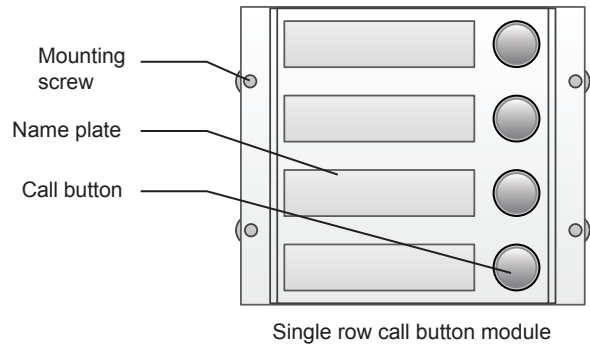
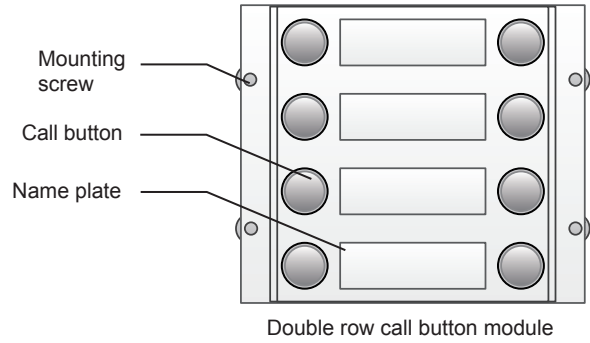

2. Call codes

The DMR21 automatically assigns the call codes to the connected module's buttons. Regardless of the structure of the call button module, the button numbers are listed from the top to bottom and from left to right (in the case of double row buttons):

* **Examples:**

In the case of double row buttons:

- DIP3 switch set to off

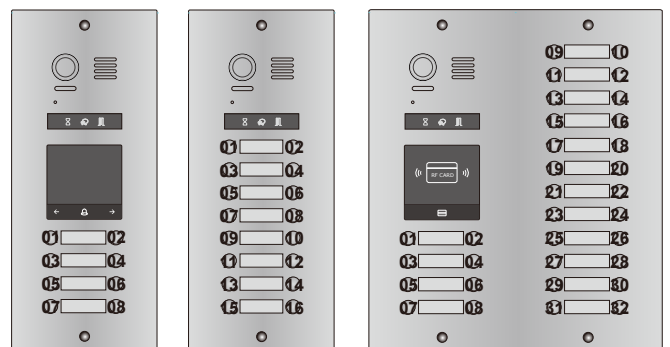

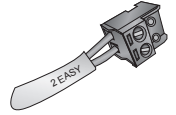

In the case of single row buttons:

- DIP3 switch set to off

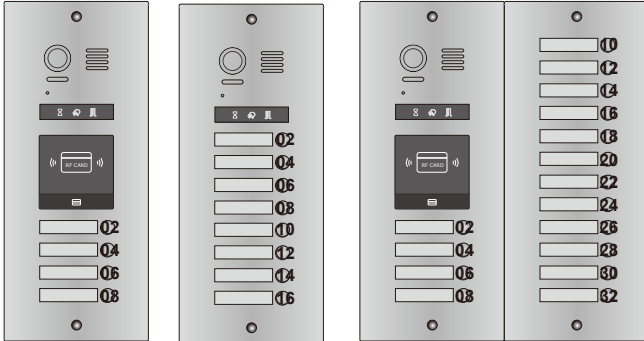

- DIP3 switch set to on

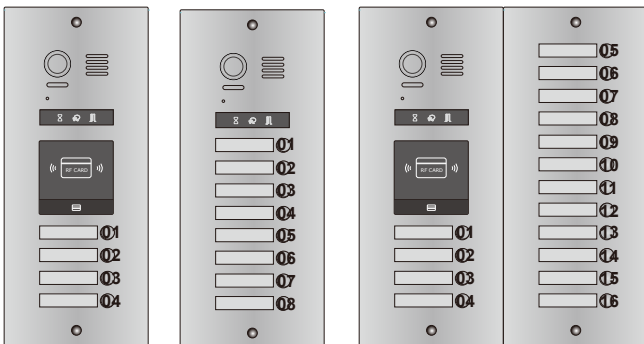

3. Address description

NO.	Functions
01	Call apartment 01
02	Call apartment 02
03	Call apartment 03
04	Call apartment 04
05	Call apartment 05
06	Call apartment 06
07	Call apartment 07
08	Call apartment 08

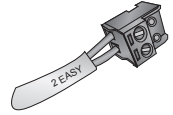

TERMINAL DESCRIPTION

• Video entry module

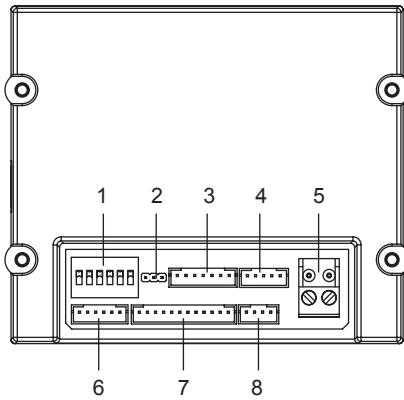

NO.	Name	Descriptions
1	SET	DIP switches for system configurations
2	JP-LK	For electronic lock safety type setting
3	CN/KMB	Call button module connection port
4	CN/T-COIL	Reserved
5	Bus	Non-polarity bus line, connect to power comb unit
6	CN-LK	Electric lock and exit button connection port
7	CN/FUN	Touch sensor keypad module or TFT display module connection port
8	CN/WGN	Card reader module connection port

• Keypad and TFT module

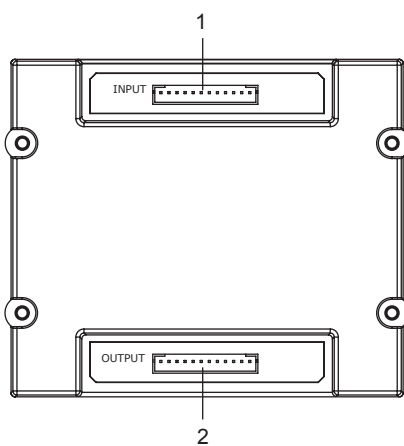

NO.	Name	Descriptions
1	CN/FUN_IN	Connect to CN/FUN of video entry module
2	CN/FUN_OUT	Connect to next keypad or TFT module

• Card reader module

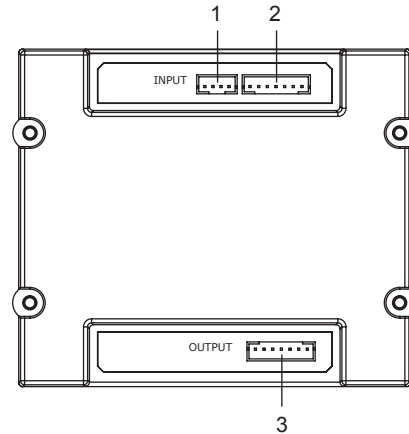

NO.	Name	Descriptions
1	JWGN1	Connect to CN/WGN of video entry module
2	JKB'	Connect to next call button module
3	JKB	Connect to next call button module

• Call button module

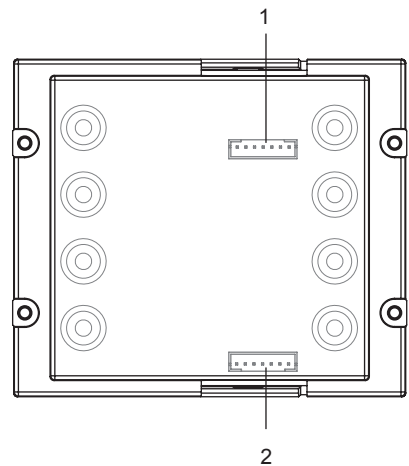

NO.	Name	Descriptions
1	INPUT	Connect to CN/KMB of video entry module
2	OUTPUT	Connect to next call button module

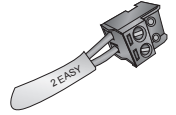

CONNECTIONS

• DMR21/D16

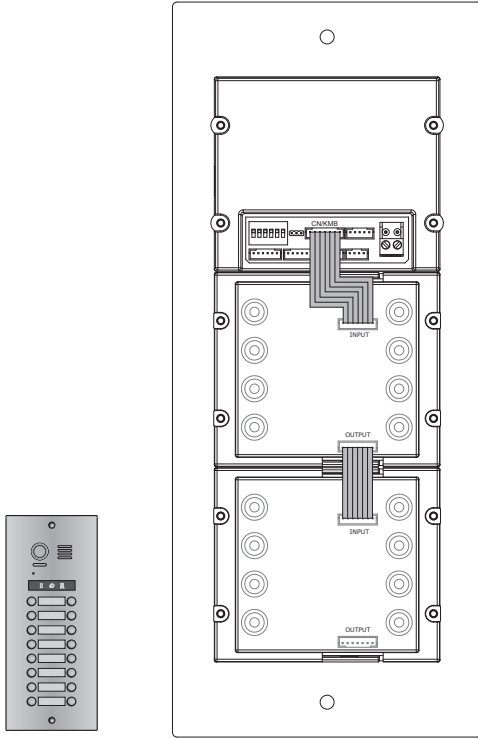

• DMR21/T4/D8

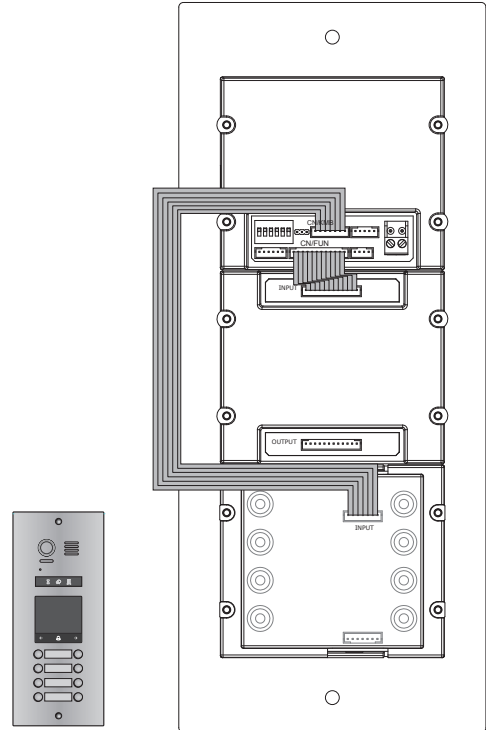

• DMR21/ID/S4

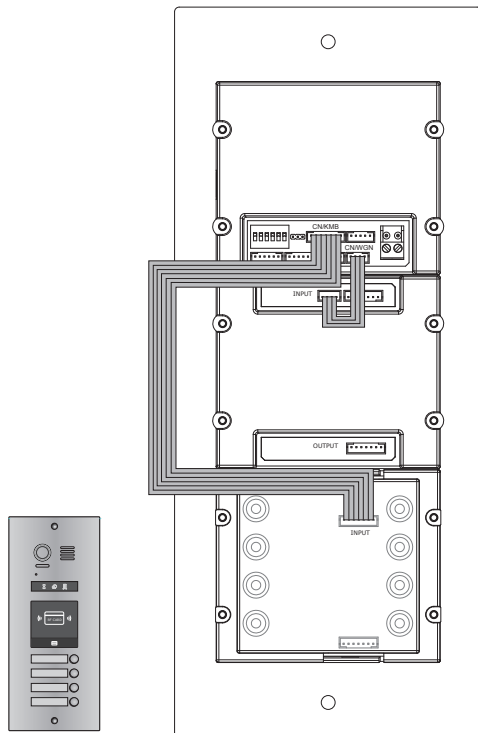

• DMR21/ID/KP

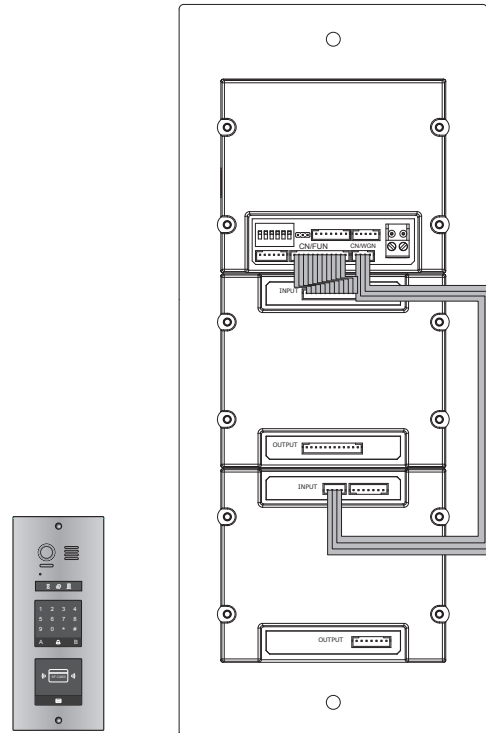

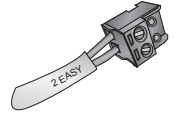

• **DMR21/S8+F3**

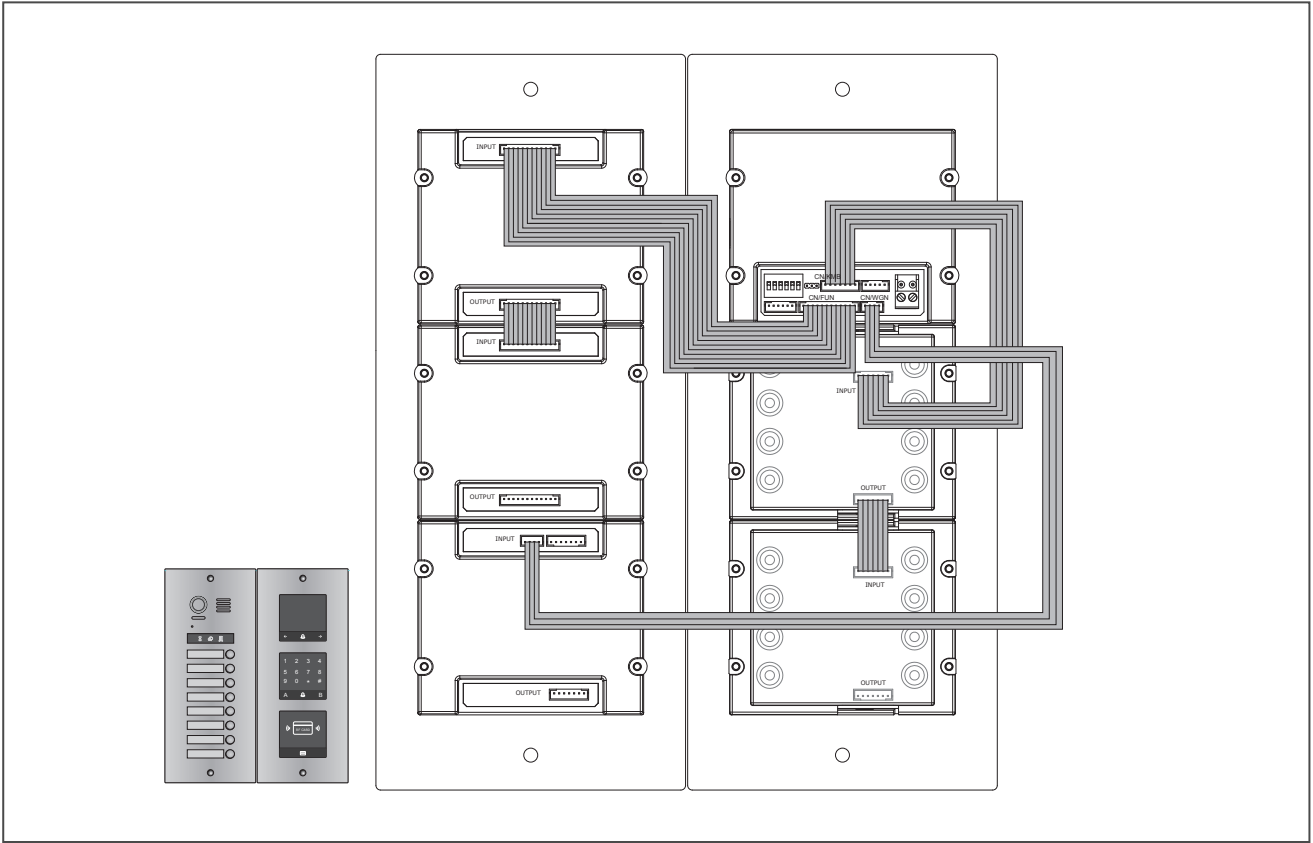

• **DMR21/ID/KP**

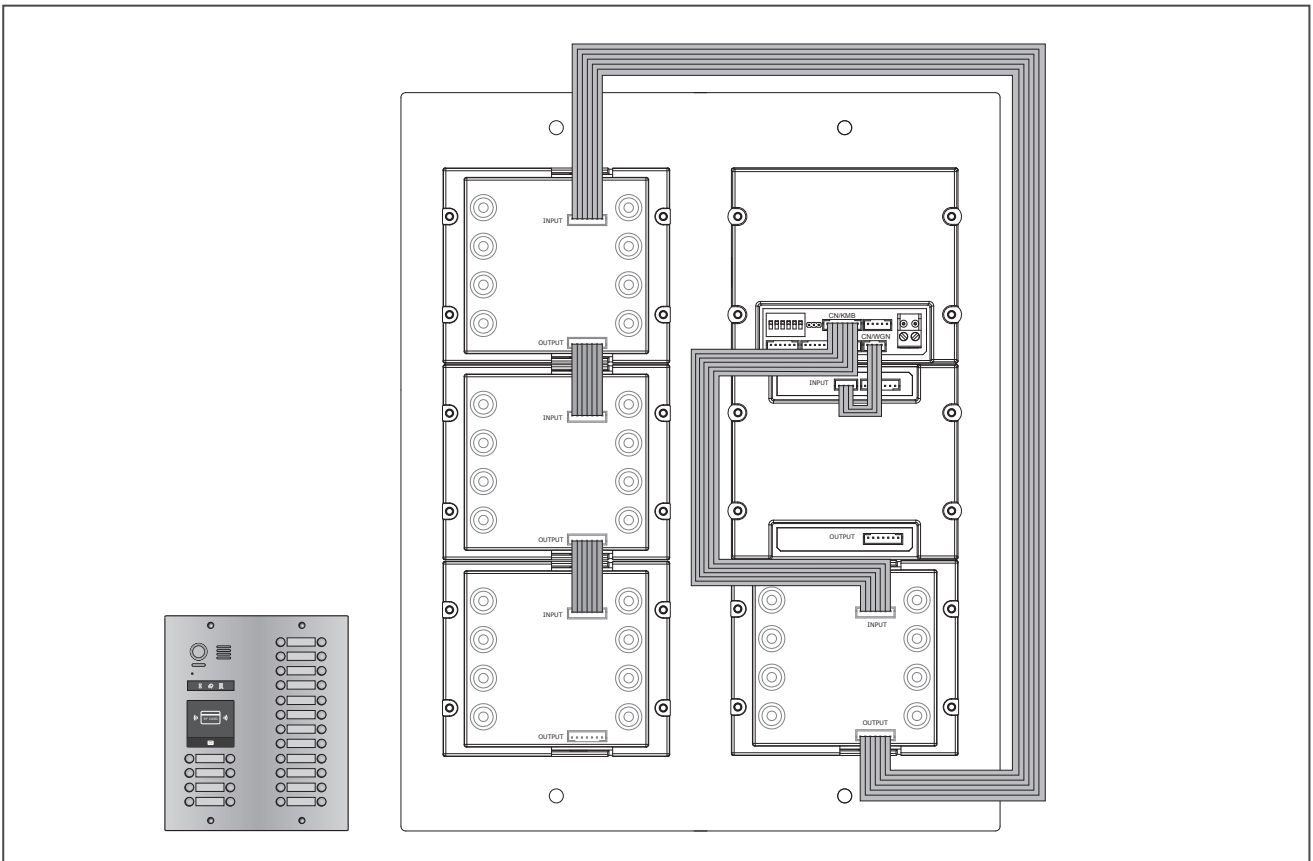

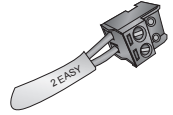

COMMON DOOR STATION SETTING

1.Namelist.txt file Setting:

- i) Create a TXT file, and named Namelist.
- ii) Open the Namelist.txt file, and input 5 [] symbols. Each [] symbol has its meaning, see the following picture.

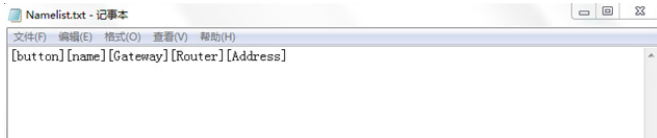

Description:

Button: DMR21 button which you need to set.

Name: It will be displayed on TFT module.

Gateway: Set the Gateway mode recording to BDU address. [08~15] means BDU address 01~08

Router: Set the Router mode recording to BDU address.[01~08] means BDU address 01~08

Address: Set the monitor address you want to call.

- iii) Edit Namelist.txt file. For example, as the following picture.



Definition:

[001][Alan_1][08][00][01]

Press the first button, it would call the monitor 01 in BDU 1, and it is displayed Alan_1 on TFT module.

2.Work Mode Setting:

This section will be reserved.

3.Namelist Update:

For more details. Please refer to the following section of **Namelist Update By SD Card.**

4.Calling

• Calling By Buttons

Press the call button to call corresponding monitors.

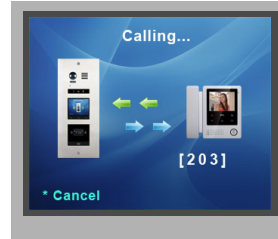

• Calling By Namelist

- i) Press touch sensor button to show the name list.

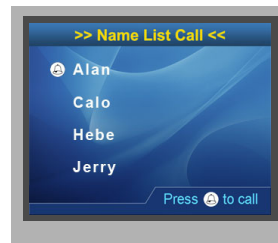

- ii) Select the name, then press touch sensor button to call.



• Calling By Keypad Module

Input the room number on keypad(with keypad module) and press touch sensor button to call the corresponding monitor.



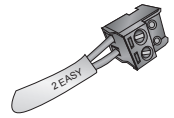

SOFTWARE UPDATE

1. Format SD card
2. Copy the Update DMR21.bin file to SD card by computer.



3. Update software:

i) Power on the DMR21, and set DIP6 switch to ON, as the following picture shows:

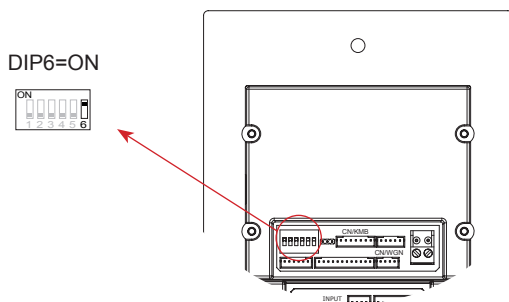

ii) Insert SD card to slot.



iii) A long warning sound of “BP+” will be sent out, and the **Status indicator** is turned on.



iii) After 3 seconds, all the indicators are turned on.



iii) After 20 seconds, a long sound of “BP+” will be sent out, and all indicators are turned off. It means **Software update** is finished.



STONE UPDATE

1. Format SD card
2. Copy the Update Ring.bin file to SD card by computer.



3. Update ringtone:

i) Power on the DMR21, and set DIP6 switch to ON, as the following picture shows:

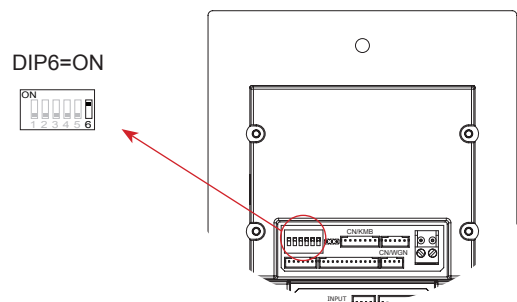

ii) Insert SD card to slot.



iii) A long warning sound of “BP+” will be sent out, and the **Talk indicator** is turned on.



iii) After 20 seconds, a long sound of “BP+” will be sent out, and the **Talk indicator** is turned off. It means **Tone update** is finished.



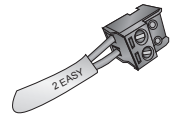

NAMELIST UPDATE

• **Update by SD card**

1. Format SD card
2. Copy the Update Nodelist.bin file to SD card by computer.



3. Update nodelist:

i) Power on the DMR21, and set DIP6 switch to ON, as the following picture shows:

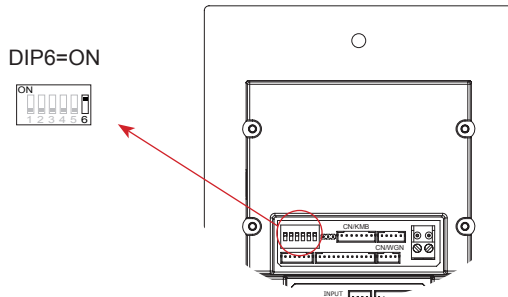

ii) Insert SD card to slot.



iii) A long warning sound of "BP+" will be sent out, and the **Talk indicator** is turned on.



iiii) After 20 seconds, a long sound of "BP+" will be sent out, and the **Talk indicator** is turned off, It means **Nodelist update** is finished.

