

Έτος ίδρυσης  
1975

2EASY

# Sambo Hellas

Ψηφιακή Θυροτηλέοραση 2 καλωδίων  
Θυροτηλέοραση Wi-Fi

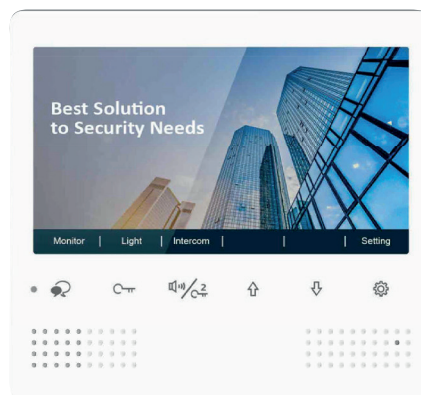

ΚΑΤΑΛΟΓΟΣ ΠΡΟΪΟΝΤΩΝ

2022

NEW

DT821  
Modularized

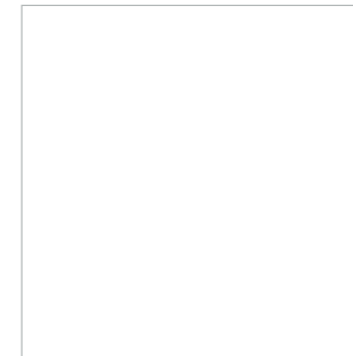

Stainless Steel Cutting  
Fingerprint-proof



Logo by  
Laser Engrave



RoHS REACH

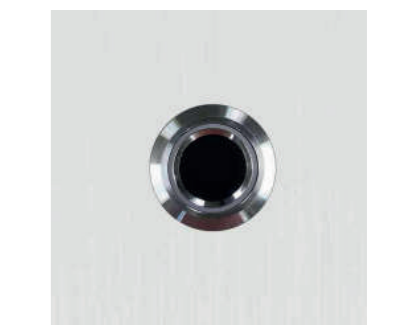
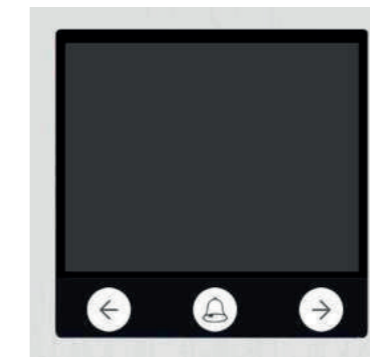
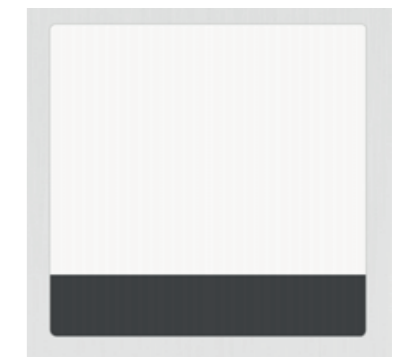
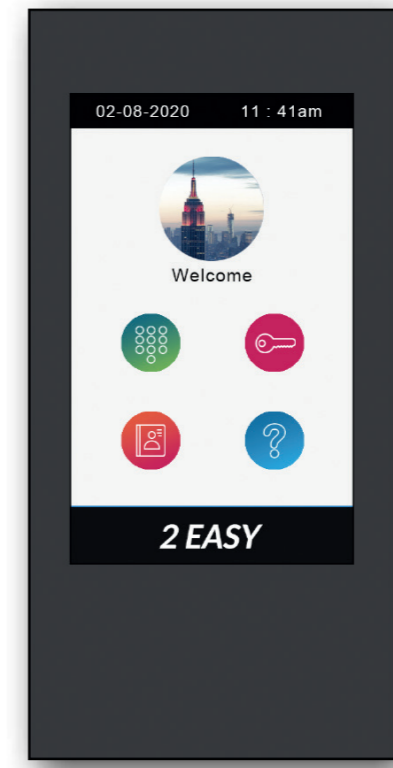

INDEX

- System Introduction.....P04-07
- Product Photos with 1:1 Scale With Product Information.....P08-51
  - Villa Outdoor Station.....P08-21
  - Apartment Outdoor Station.....P22-33
  - Memory & Wi-Fi Indoor Station.....P34-39
  - Standard Monitor .....P40-51
- Ordering Information.....P52-61
- Appendix and Notes.....P62-63

# General Layout

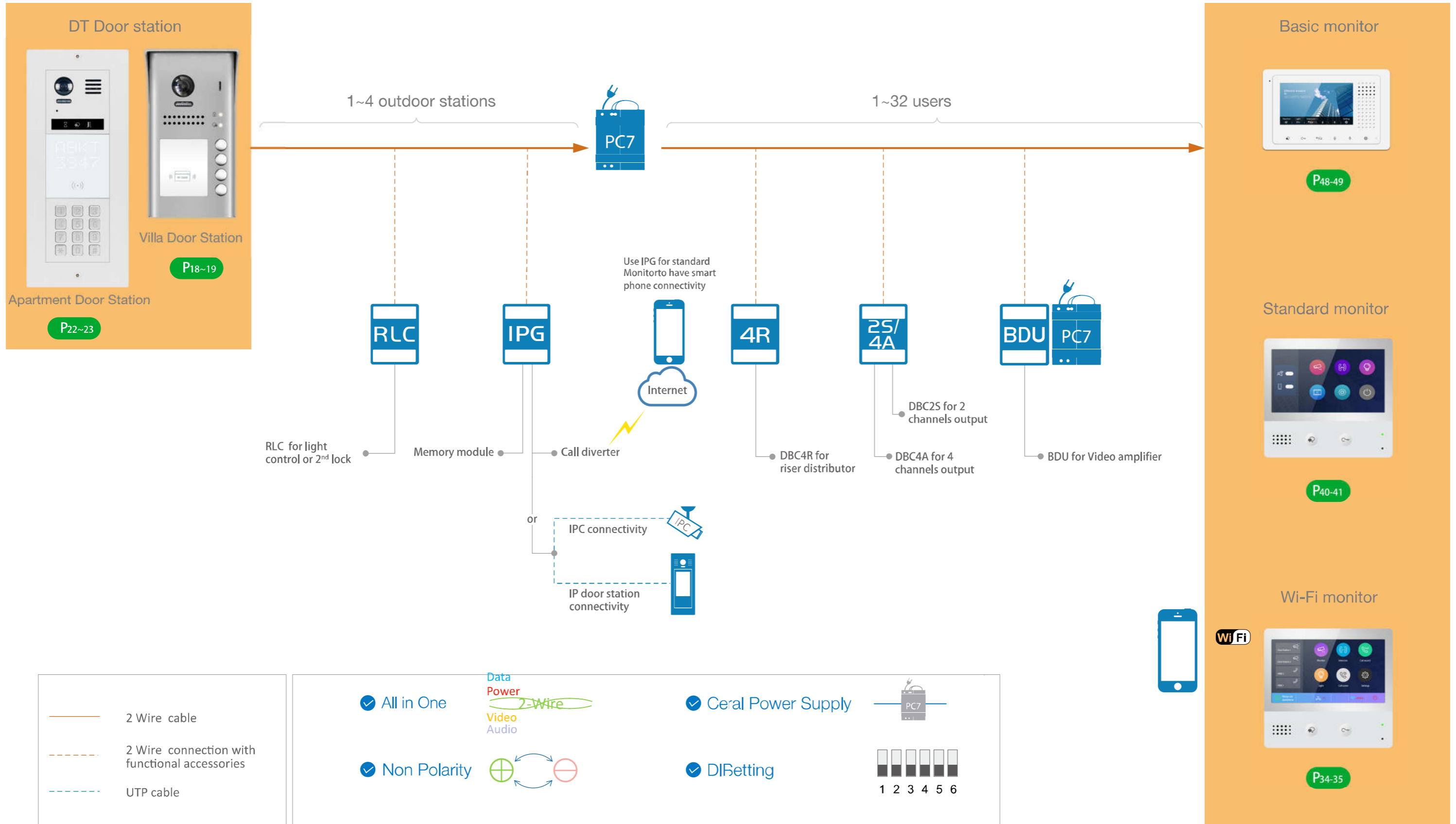

# Typical Wring In-out Topology

## Connection Diagram

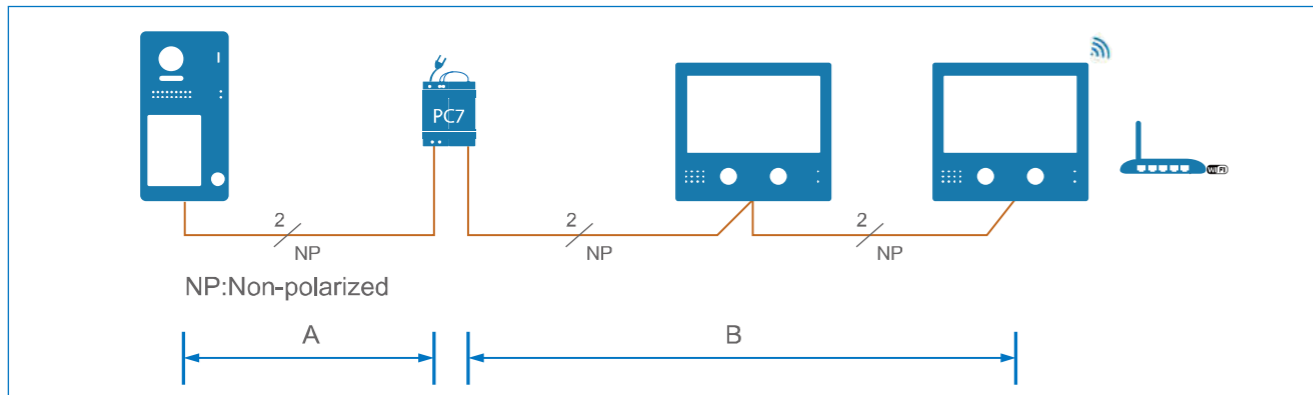

## Cable and Distance

Cable	A(m)	B(m) ≤ 2 IM*	B(m) ≤ 16 IM*
CAT5 Cable (Combined)	40	80	—
Pair Cable (Parallel) 2X0.75 mm <sup>2</sup>	30	50	—
Twisted Cable 2X0.75 mm <sup>2</sup>	60	100	40
Twisted Cable 2X1.0 mm <sup>2</sup>	80	120	60

\*IM means Indoor monitor.

Bus amplifier could extend the distance or strengthen signals while cable is too thin.

## Extending Monitors(up to 8)

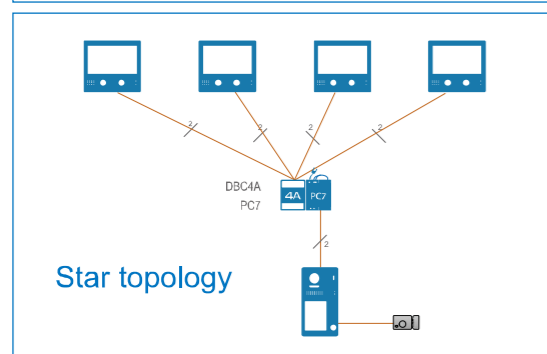
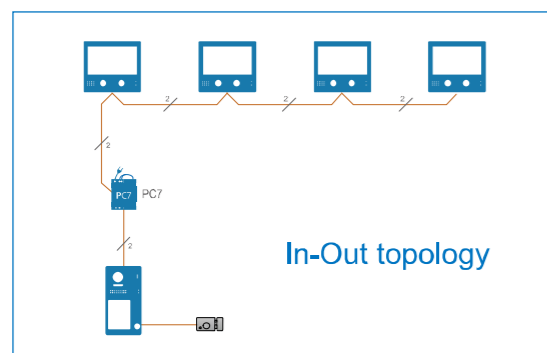

## Extending Door/CCTV Cameras

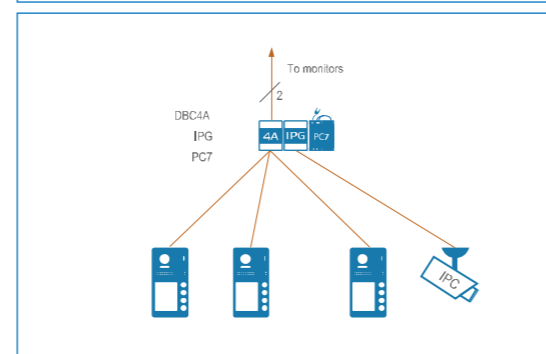
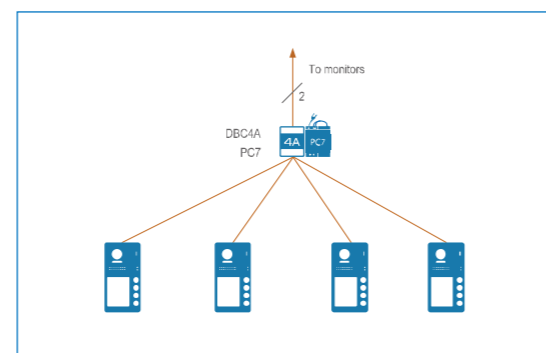

# Typical Apartment Wring

## Connection Diagram

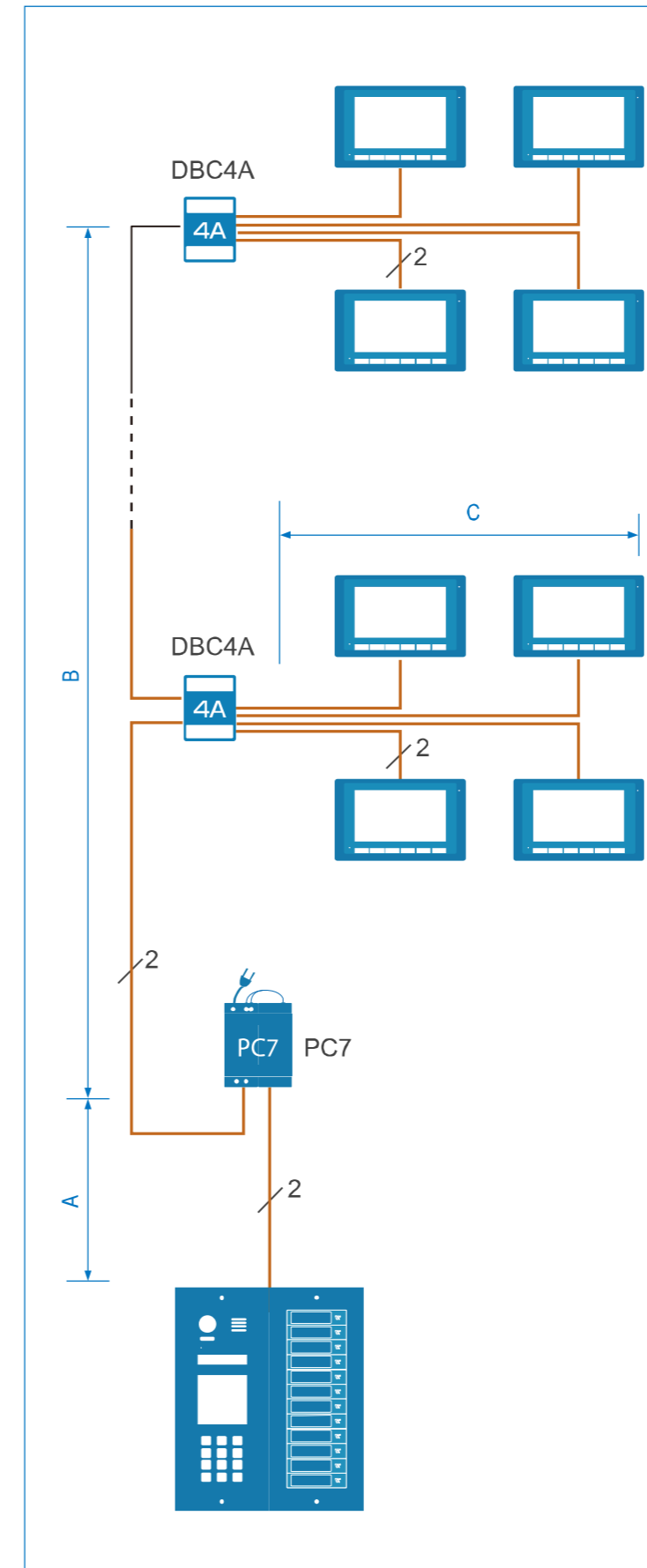

## Cable and Distance

The maximum distance of the wiring is limited in the DT system. Using different cables may also effect the maximum distance of the system can reach.

## When Monitor Quantity < 20

Cable Usage	A	B	C
Twisted cable 2x0.75mm <sup>2</sup>	60	60	30
Twisted cable 2x1 mm <sup>2</sup>	80	80	40

## When Monitor Quantity ≥ 20

Cable Usage	A	B	C
Twisted cable 2x1 mm <sup>2</sup>	70	30	20
Twisted cable 2x1.5 mm <sup>2</sup>	70	50	30

Cables should be non-shielded! And the twisted cables are recommended, if non-twisted cable is used, the total distance will remain only to half.

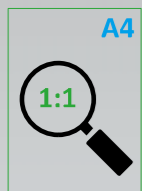

**Description**

2-wire system villa door station with 105 degree view angle or fisheye camera.

**Features**

- Aluminum panel
- Two types camera lens choice
- Unlock and talk indicator
- Auto light up sensor
- Surface mounting
- IP54

**Dimension and mount**

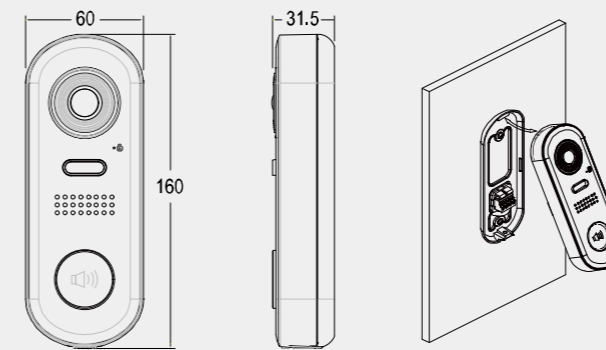

**Terminal Description**

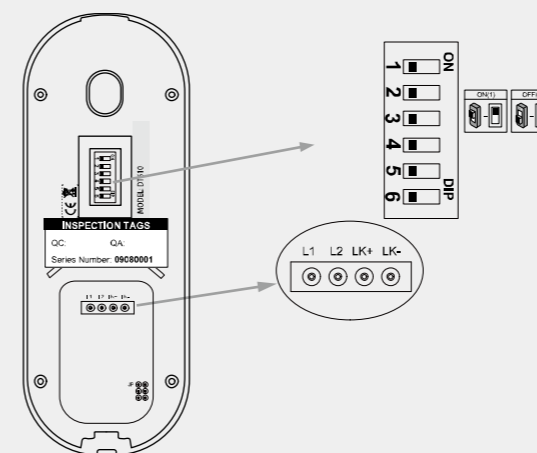

**L1,L2:** Connect to the bus line, no polarity.  
**LK+:** Lock power(+) output.  
**LK-:** Lock power(-) output, connect to the power(-) input of locks(only when using the door station to power the locks, if using the external power supply for the locks, the LK- will not be connected).  
**JP:** Lock Control Jumper.

**DIP**

**Bit 1&2:** to set door station address, total 4 door stations can be supported. Please refer to door station address setting.  
**Bit 3&4:** to set unlock time for door station. Please refer to unlock time setting.  
**Bit 5:** to set unlock mode for door station (0(OFF):opened/1(ON):closed).  
**Bit 6:** 0(OFF) --> 1(ON), to enter setting mode.

**Packing Information**

**Single Package**



Dimensions: 166(H)×103(W)×60(D)mm  
 Gross Weight: 0.53Kg

**Carton Package**



Carton: 340 (H)×530 (W)×258 (D)mm  
 Quantity: 32PCS

# DT611 Keypad access

Villa door station, Wall mount

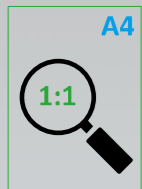

# Product Information

## Description

2-wire system villa door station with keypad access and fisheye camera.

## Features

- Stainless steel front panel and keys
- Fisheye camera(max.170 degree)
- \*105 degree view angle is optional
- Unlock and talk indicator
- Auto light up sensor
- Mechanical keypad access
- Voice prompt
- Surface mounting by SS rainy cover
- IP54

## Dimension and mount

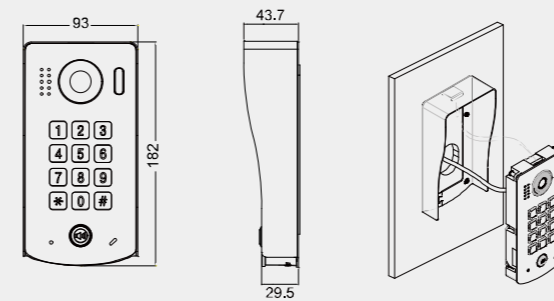

## Terminal Description

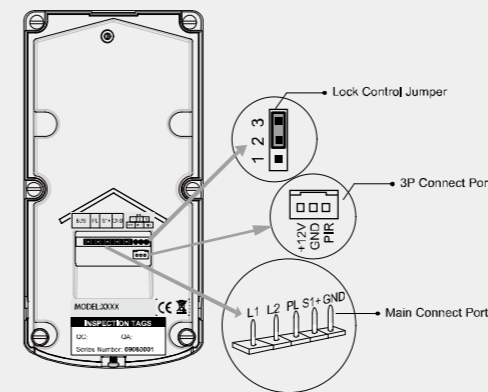

**Lock Control Jumper:** To select the lock type.  
**3P Connect Port:** 1. If the external key module is detected online, the port will be automatically as a communication port;  
 2. If above cases are not activated, GND and PIR can be used as exit button port.

**Main Connect Port:** To connect the bus line and the electronic locks.

**L1,L2:** Connect to the bus line, no polarity.

**PL:** External lock power input, connect to the power positive(power +).

**S1+,GND:** Lock power connection port.

## Packing Information

### Single Package



Dimensions: 200(H)×100(W)×60(D)mm

Gross Weight: 0.76Kg

### Carton Package



Carton: 265(H)×415 (W)×360(D)mm

Quantity: 28PCS

# DT611F Keypad access

Villa door station, Flush mount

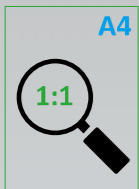

# Product Information

## Description

2-wire system villa door station with keypad access and fisheye camera.

## Features

- Stainless steel front panel and keys
- Fisheye camera(max.170 degree)
- \*105 degree view angle is optional
- Unlock and talk indicator
- Auto light up sensor
- Mechanical keypad access
- Voice prompt
- Flush mounting by SS rainy cover
- IP54

## Dimension and mount

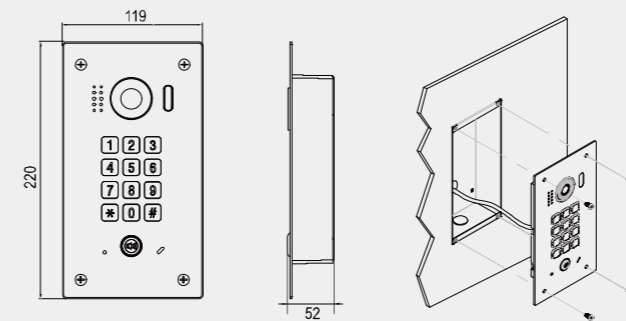

## Terminal Description

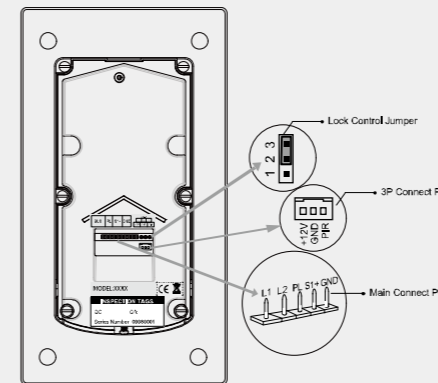

**Lock Control Jumper:** To select the lock type.  
**3P Connect Port:** 1. If the external key module is detected online, the port will be automatically as a communication port;  
2. If above cases are not activated, GND and PIR can be used as exit button port.

**Main Connect Port:** To connect the bus line and the electronic locks.

**L1,L2:** Connect to the bus line, no polarity.

**PL:** External lock power input, connect to the power positive(power +).

**S1+,GND:** Lock power connection port.

## Packing Information

### Single Package



Dimensions: 225(H)×140(W)×63(D)mm

Gross Weight: 1.15Kg

### Carton Package



Carton: 265(H)×415 (W)×360(D)mm

Quantity: 15PCS

# DT611 Touchkey Access

Villa door station, Wall mount



# Product Information

## Description

2-wire system villa door station with touch keypad access and fisheye camera.

## Features

- Stainless steel front panel
- Fisheye camera(max.170 degree)  
\*105 degree view angle is optional
- Unlock and talk indicator
- Auto light up sensor
- Nameplate with backlit
- Touch keypad access with blue backlit
- Voice prompt
- Surface mounting by SS rainy cover
- IP54

## Dimension and mount

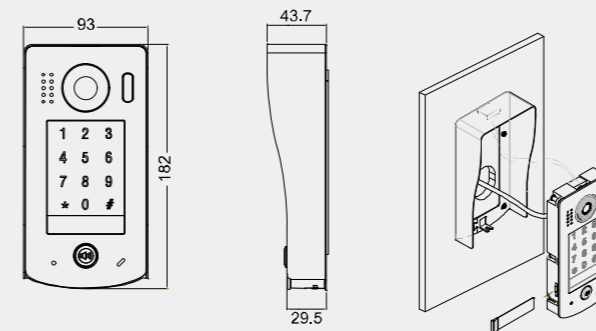

## Terminal Description

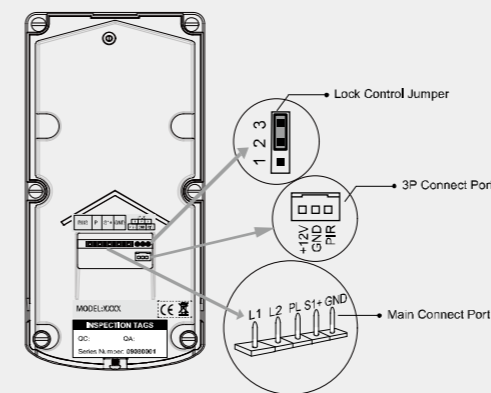

**Lock Control Jumper:** To select the lock type.  
**3P Connect Port:** 1. If the external key module is detected online, the port will be automatically as a communication port;

2. If above cases are not activated, GND and PIR can be used as exit button port.

**Main Connect Port:** To connect the bus line and the electronic locks.

**L1,L2:** Connect to the bus line, no polarity.

**PL:** External lock power input, connect to the power positive(power +).

**S1+,GND:** Lock power connection port.

## Packing Information

### Single Package



Dimensions: 200(H) $\times$ 100(W) $\times$ 60(D)mm

Gross Weight: 0.76Kg

### Carton Package



Carton: 265(H) $\times$ 415 (W) $\times$ 360(D)mm

Quantity: 28PCS



# DT611F Touchkey Access

Villa door station, Flush mount

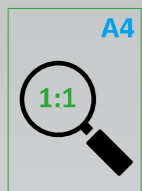

# Product Information

## Description

2-wire system villa door station with touch keypad access and fisheye camera.

## Features

- Stainless steel front panel
- Fisheye camera(max.170 degree)  
\*105 degree view angle is optional
- Unlock and talk indicator
- Auto light up sensor
- Nameplate with backlit
- Touch keypad access with blue backlit
- Voice prompt
- Flush mounting by SS rainy cover
- IP54

## Dimension and mount

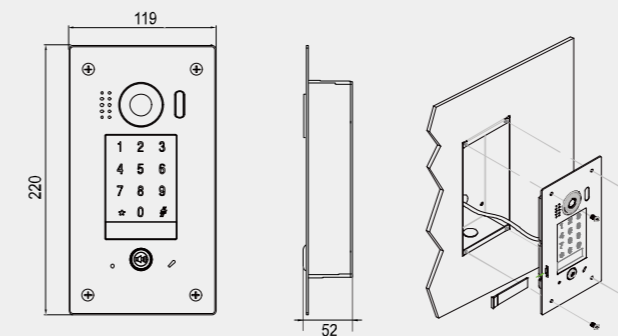

## Terminal Description

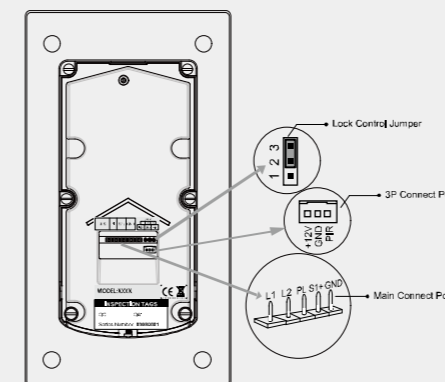

- Lock Control Jumper:** To select the lock type.
- 3P Connect Port:** 1. If the external key module is detected online, the port will be automatically as a communication port;  
2. If above cases are not activated, GND and PIR can be used as exit button port.

**Main Connect Port:** To connect the bus line and the electronic locks.

**L1,L2:** Connect to the bus line, no polarity.

**PL:** External lock power input, connect to the power positive(power +).

**S1+,GND:** Lock power connection port.

## Packing Information

### Single Package



Dimensions: 225(H)×140(W)×63(D)mm  
Gross Weight: 1.15Kg

### Carton Package



Carton: 265(H)×415 (W)×360(D)mm  
Quantity: 15PCS

# DT607 Wall Mount

1~4 push-button door station, Zinc alloy



# Product Information

## Description

2-wire system villa door station with 105 degree view angle or fisheye camera and proximity access.

## Features

- Zinc alloy panel and rainy cover
- Fisheye camera(max.170 degree)
- \*105 degree view angle is optional
- Unlock and talk indicator
- Auto light up sensor
- Embedded RFID reader(125khz)
- Big nameplate display
- 1~4 push buttons choice
- Surface mounting
- IP54

## Dimension and mount

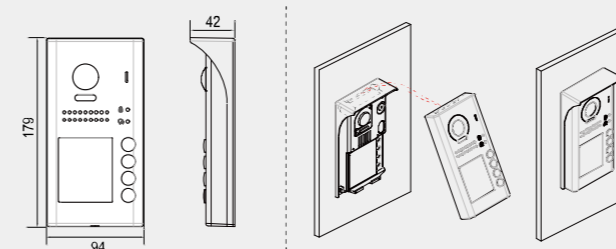

## Terminal Description

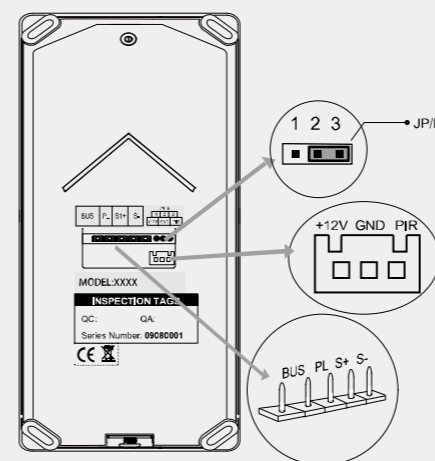

- JP/LK:** Lock control jumper, to select the lock type.
- +12V:** 12VDC power output.
- GND:** Power ground.
- PIR:** Reserved.
- BUS:** Connect to the bus line, no polarity.

- PL:** External lock power input, connect to the power positive(power +).
- S+:** Lock power(+) output.
- S-:** Lock power(-) output, connect to the power(-) input of locks(only when using the camera to power the locks, if using the external power supply for the locks, the S- will not be connected).

## Standard specification



## Packing Information

### Single Package



Dimensions: 202(H)×100(W)×60(D)mm

Gross Weight: 0.77Kg

### Carton Package



Carton: 415 (H)×360 (W)×265 (D)mm

Quantity: 28PCS

# DT607 Flush Mount

1~4 push-button door station, Zinc alloy



# Product Information

## Description

2-wire system villa door station with fisheye camera and proximity access.

## Features

- 304 Stainless steel front panel
- Fisheye camera(max.170 degree)  
\*105 degree view angle is optional
- Unlock and talk indicator
- Auto light up sensor
- Embedded RFID reader(125khz)
- Big nameplate display
- 1~4 push buttons choice
- Flush mounting
- IP54

## Dimension and mount

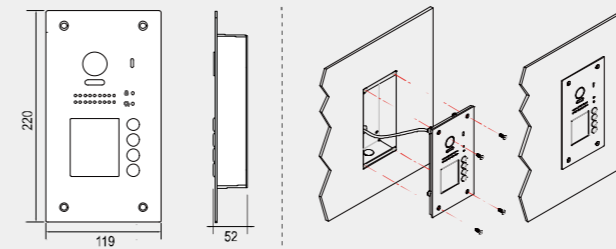

## Terminal Description

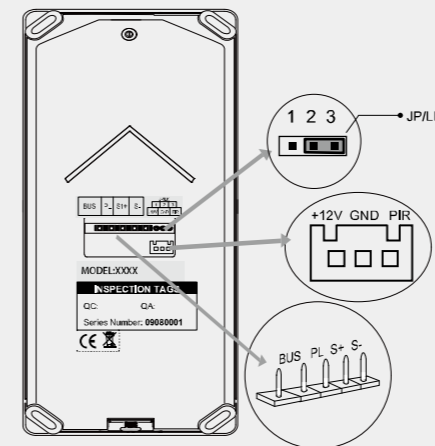

**JP/LK:** Lock control jumper, to select the lock type.  
**+12V:** 12VDC power output.  
**GND:** Power ground.  
**PIR:** Reserved.  
**BUS:** Connect to the bus line, no polarity.

**PL:** External lock power input, connect to the power positive(power +).

**S+:** Lock power(+) output.

**S-:** Lock power(-) output, connect to the power(-) input of locks(only when using the camera to power the locks, if using the external power supply for the locks, the S- will not be connected).

## Packing Information

Single Package



Dimensions: 225(H)×140(W)×63(D)mm

Gross Weight: 0.97Kg

Carton Package



Carton: 415 (H)×360 (W)×265 (D)mm

Quantity: 15PCS

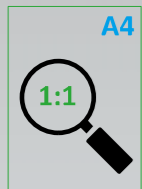

**Description**

2-wire apartment system color fisheye camera modularity outdoor station.

**Features**

- Fingerprint-proof SS front panel
- Fisheye lens with Max.170 degree view angle
- Auto sensor LED for night view
- Voice prompt
- PMMA, Dot-Matrix display,
- Card reader, 125KHz & 13.56MHz Dual Standard

**Terminal Description**

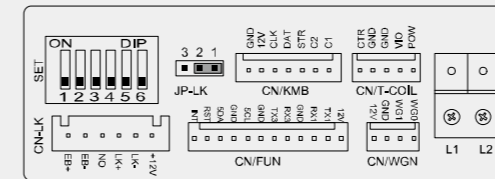

- +12V:** 12VDC power output.
- LK-:** Power ground.
- LK+:** Common contact of the relay.
- NO.:** normally open contact of the relay(refer to DT technical guide for Lock connection detail informations).
- EB+:** exit button positive connection port.
- EB-:** exit button negative connection port.
- JP-LK:** for electronic lock safety type setting (refer to door lock connections).
- SET:** DIP switches for system configurations.
- CN/KMB:** call button module connection port.
- CN/T-COIL:** reserved.
- CN/FUN:** Mechanical keypad module or TFT display module connection port.
- CN/WGN:** card reader module connection port.
- Bus(L1,L2):** non-polarity bus line,connect to PC7 (power comb unit).

**Dimension and mount**

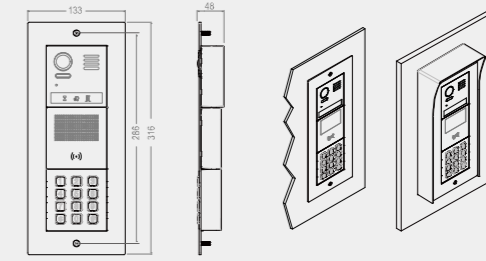

**Standard specification**

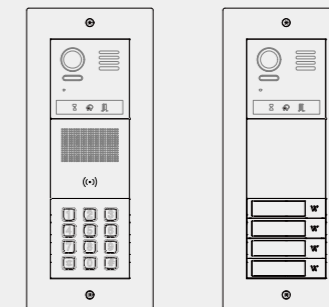

**Packing Information**

**Single Package**



Dimensions: 171(H)X420(W) X98(D) mm  
Gross Weight: 1.56Kg

**Carton Package**



Carton: 265(H)X415 (W)X360(D)mm  
Quantity: 7PCS



## Description

[VD]2-wire system video controller module  
 [AD]2-wire system audio controller module

## Features

- Fingerprint-proof SS front panel
- Fisheye lens with Max.170 degree view angle
- Talking &unlocking led indication
- Auto sensor LED for night view
- Voice Prompt
- [AD]Full audio controller choice

## Dimension



## Terminal Description

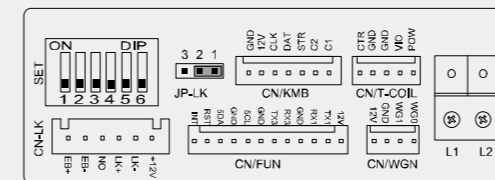

- +12V:** 12VDC power output.
- LK-:** Power ground.
- LK+:** Common contact of the relay.
- NO.:** normally open contact of the relay(refer to DT technical guide for Lock connection detail informations).
- EB+:** exit button positive connection port.
- EB-:** exit button negative connection port.
- JP-LK:** for electronic lock safety type setting (refer to door lock connections).

- SET:** DIP switches for system configurations.
- CN/KMB:** call button module connection port.
- CN/T-COIL:** reserved.
- CN/FUN:** Mechanical keypad module or TFT display module connection port.
- CN/WGN:** card reader module connection port.
- Bus(L1,L2):** non-polarity bus line,connect to PC7 (power comb unit).

## Packing Information

### Single Package



Dimensions: 110(H) x 110(W) x 55(D)mm  
 Gross Weight: [VD]0.3Kg  
 [AD]0.3Kg

### Carton Package



Carton: 258(H) x 530(W) x 340(D)mm  
 Quantity: 54PCS

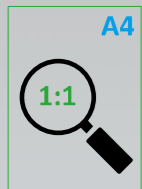

## Description

[M4]Call module with 4 physical push buttons  
 [S4]Call module with 4 touch sensor buttons

## Features

- [M4]Fingerprint-proof SS front panel
- [M4]Mechanical SS push button
- [S4]Aluminum button frame
- [S4]Touch button by light sensor
- [S4]Single button frame is replaceable
- [M4 & S4]Name plate with backlit
- [M4 & S4]1~4 button module for chose

## Dimension

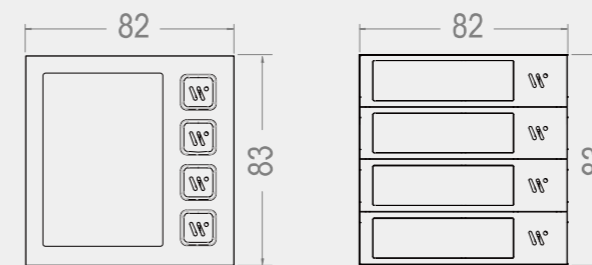

## Terminal Description

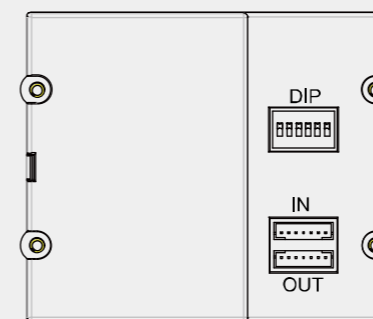

**DIP:** S4 Module address settings.  
**IN:** Connect to main or last module.  
**OUT:** Connect to next module.

## Packing Information

### Single Package



Dimensions: 110(H) x 110(W) x 55(D)mm

Gross Weight: [M4]0.35Kg  
 [S4]0.3Kg

### Carton Package



Carton: 258(H) x 530(W) x 340(D)mm

Quantity: 54PCS

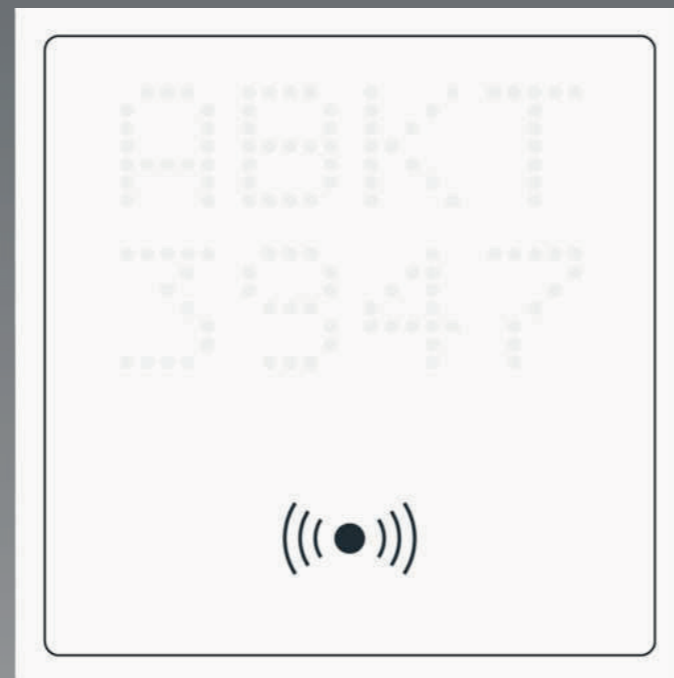
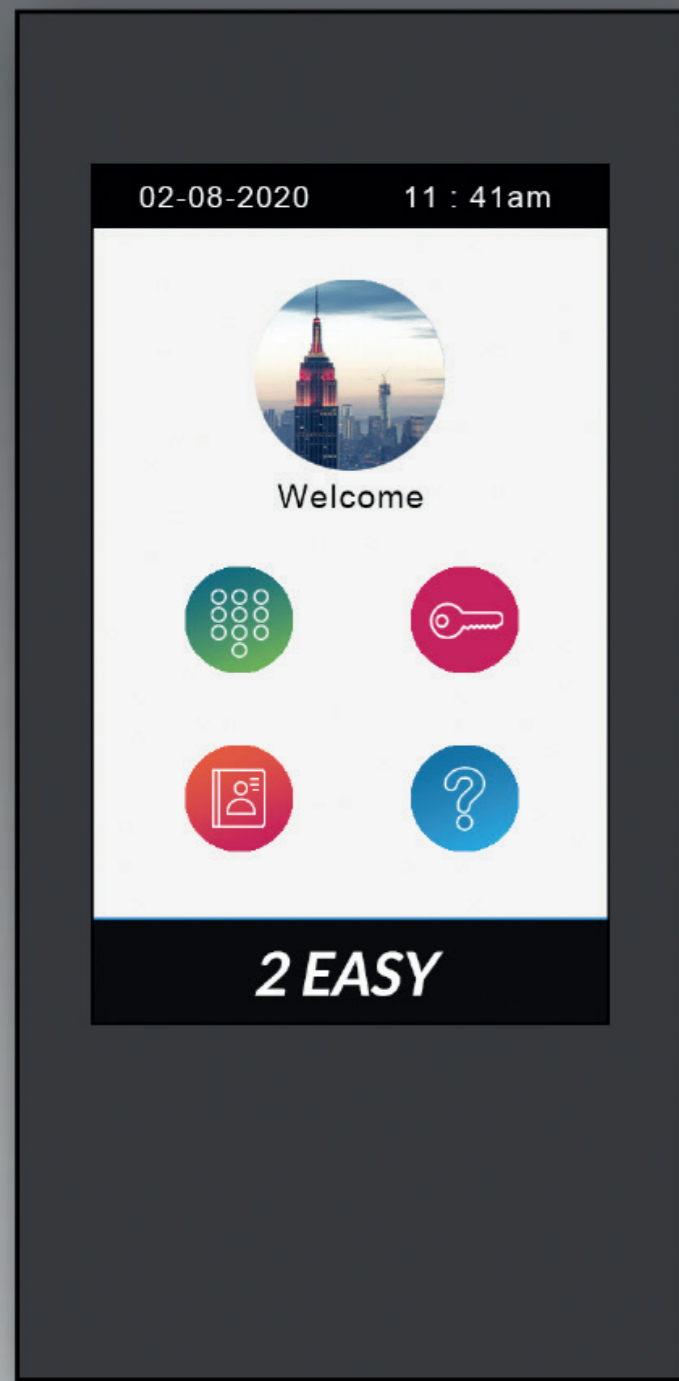

## Description

[T5]2-wire system 5 inch touch operation module  
 [DR]Dot-Matrix display Module  
 [MK]Mechanical Keypad Module

## Features

- [T5] Full glass front panel
- [T5]5" TFT display with touch screen operation
- [T5]Call & code unlock & Card unlock integrations
- [T5]RFID reader with 125KHz & 13.56MHz Dual Standard
- [T5]2 Modules-size design
- [DR]PMMA panel
- [DR]Dot-Matrix display[DR]
- [DR]RFID reader with 125KHz & 13.56MHz Dual standard
- [DR]Max.320 cards management
- [MK]Fingerprint-proof SS front panel
- [MK]Mechanical keypad for code unlock & room number calling

## Dimension

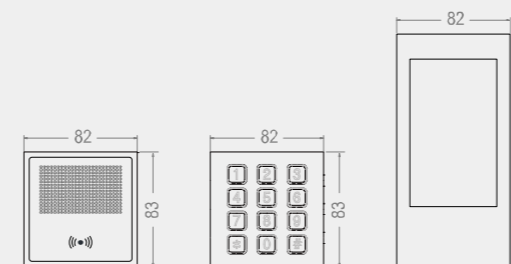

## Terminal Description

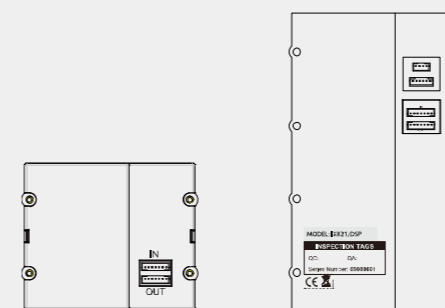

IN: Connect to main or last module.  
 OUT: Connect to next module.

## Packing Information

### Single Package

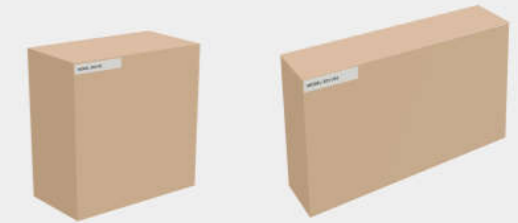

Dimensions: [T5]225(H) x140(W) x 63(D)mm  
 [DR/MK]110(H) x110(W) x 55(D)mm  
 Gross Weight: [T5]0.45Kg  
 [DR]0.3Kg  
 [MK]0.4Kg

### Carton Package



Carton: [T5]415(H) x 360(W) x 265(D)mm  
 [DR/MK]258(H) x 530(W) x 340(D)mm  
 Quantity: [T5]15PCS  
 [DR/MK]54PCS





**Description**

[TFT]3.5 inch display module  
 [LB]Information Board module with backlit  
 [FP]Fingerprint module for unlock access

**Features**

- [FP]Fingerprint-proof SS front panel
- [FP]Fingerprint unlock
- [FP]Semiconductor sensor
- [FP]Max. 200 Fingerprint management
- [LB]Fingerprint-proof SS front panel
- [LB]Label information with backlit
- [TFT]Fingerprint-proof SS front panel
- [TFT]3.5" TFT display
- [TFT]Navigation sensor button

**Dimension and mount**

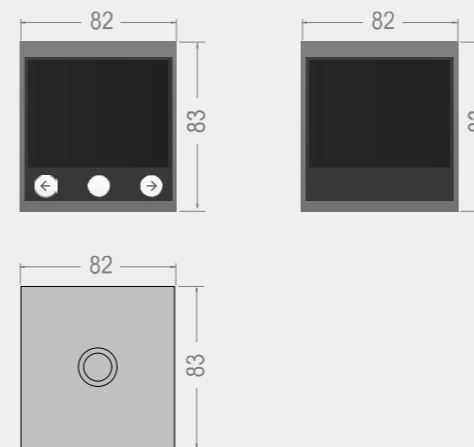

**Terminal Description**

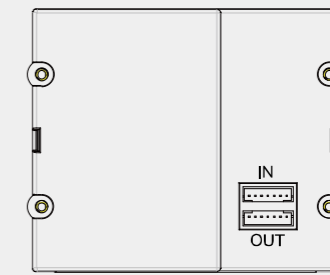

**IN:** Connect to main or last module.  
**OUT:** Connect to next module.

**Packing Information**

**Single Package**



Dimensions: 110(H) x 110(W) x 55(D)mm

Gross Weight: [TFT]0.3Kg  
 [LB]0.26Kg  
 [FP]0.35Kg

**Carton Package**



Carton: 258(H) x 530(W) x 340(D)mm  
 Quantity: 54PCS



# 821 Mounting frame

Front panel with flush mounting box

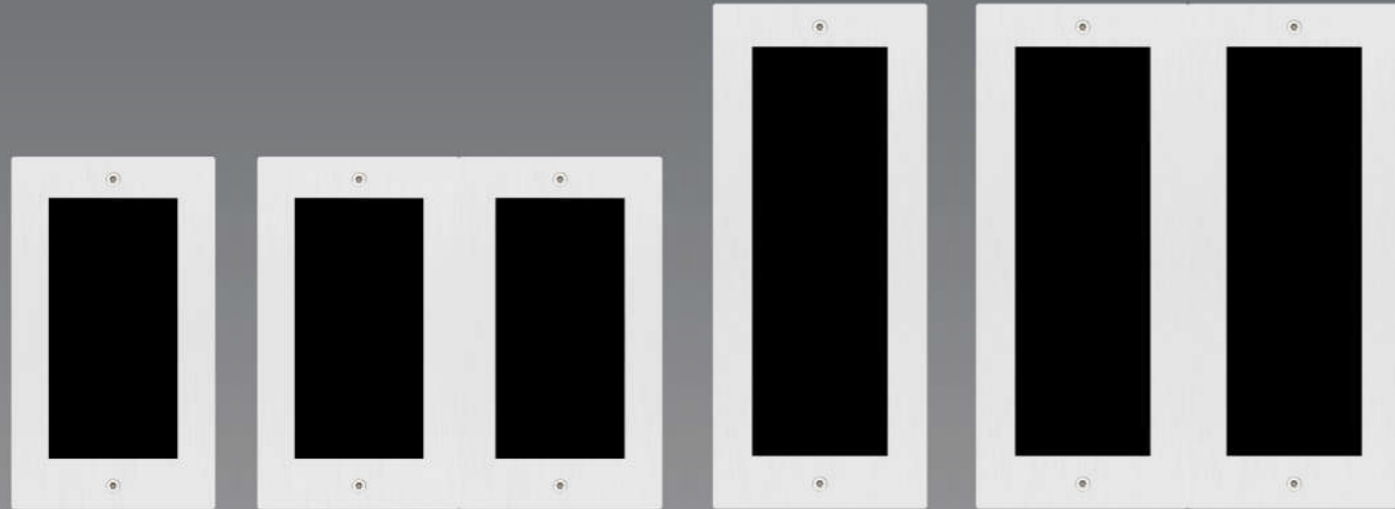

Surface mounting box with rainy cover



# Product Information

## Description

2/3/4/6 module-combination frame and rainy cover for flush and surface mounting

## Features

- Surface mount
- Zinc alloy rainy cover box
- Fingerprint-proof SS front panel
- Flush mount
- Fingerprint-proof SS front panel

## Flush mount and Surface mount

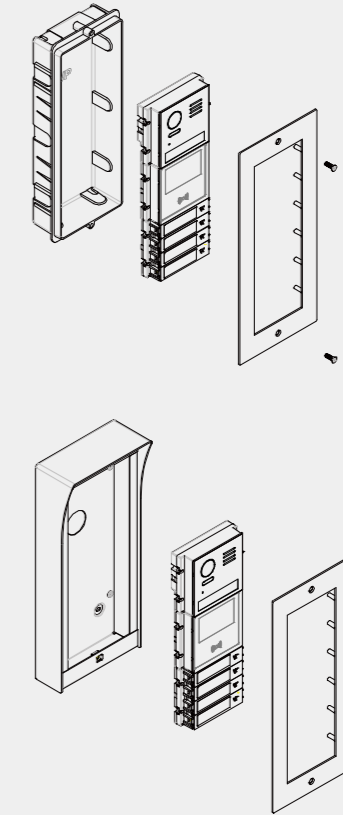

Modules	Config	Surface(mm)	Flush box(mm)	Front panel(mm)	Single package(mm)	Qty per package
2	2x1-S	235(H)x138(W)x66(D)		232(H) x133(W)x2(D)	143(H) x282(W)x76(D)	8
3	3x1-S	319(H)x138(W)x66(D)		316(H) x133(W)x2(D)	143(H) x282(W)x76(D)	7
4	2x2-S	235(H)x261(W)x66(D)		232(H) x256(W)x2(D)	274(H) x331(W)x81(D)	5
6	3x2-S	319(H) x261(W)x66(D)		316(H) x256(W)x2(D)	274(H) x331(W)x81(D)	5
2	2x1-F		231(H)x133(W)x40(D)	232(H) x133(W)x2(D)	143(H) x282(W)x76(D)	8
3	3x1-F		316(H) x133(W)x40(D)	316(H) x133(W)x2(D)	143(H) x282(W)x76(D)	7
4	2x2-F		231(H)x256(W)x40(D)	232(H) x256(W)x2(D)	274(H) x331(W)x81(D)	5
6	3x2-F		316(H) x256(W)x40(D)	316(H) x256(W)x2(D)	274(H) x331(W)x81(D)	5

2x1 Config



Dimensions: 298(H)x380(W)x325(D)mm  
Quantity: 8PCS

3x1 Config



Dimensions: 415(H)x360(W)x265(D)mm  
Quantity: 7PCS

3x2 2x2 Config



Dimensions: 495(H)x403(W)x310(D)mm  
Quantity: 5PCS



34

### Description

2-wire system 7" touch screen monitor with memory & recording and Wi-Fi connectivity.

### Features

- Touch screen
- Touch sensor button
- Navigation dot for disabled person
- Call transfer to mobile phone
- Inner picture memory and SD card storage extension
- IP camera integration
- Stair light and 2nd lock control
- Intercom and inner intercom
- Doorbell and ringer connection

### Dimension

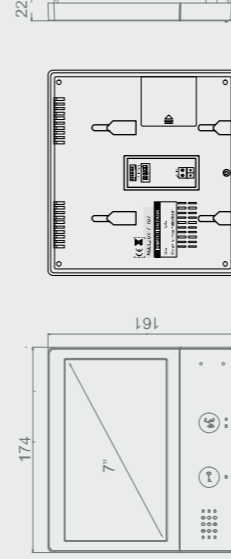

### Terminal Description

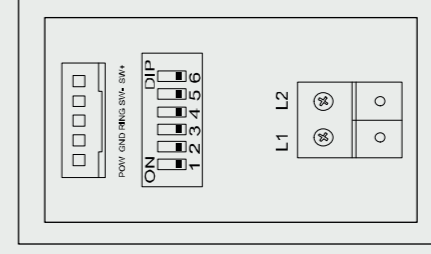

**SW+,SW-**: Extra door bell call button connection port.

**Ring,GND**: Extra buzzer connection port.

**POW,GND**: 12~16V extra power connection port.

**DIP switches**: Total 6 bits can be configured.

**Bit1 ~Bit5**: User Code setting switch.

**Bit6**: Video impedance matching switch.

**L1,L2**: Bus line terminal.

## Product Information

### Πλήκτρα αφής

Το νέο μόνιτορ Θυροτηλεόρασης σας δίνει τη δυνατότητα να απαντήσετε στον επισκέπτη μέσω του Smart Phone ακόμα και αν δεν είστε στο σπίτι και είναι συμβατή με τα υπάρχοντα συστήματα της εταιρείας μας.

Συνδέεται μέσω WiFi του διαμερίσματος σας και μεταφέρει την κλήση(Ομιλία, εικόνα, άνοιγμα πόρτας) στο κινητό του χρήστη μέσω Δωρεάν εφαρμογής για Android & Ios.

### Χαρακτηριστικά

- TFT Θόνη αφής 7" Ιντσών
- Πλήκτρα αφής
- Αποθήκευση φωτογραφίας επισκέπτη
- Δέχεται SD card 16GB για καταγραφή video
- Επιλογή μελωδίας
- Έντασης κλήσης
- Αυτόκλιση
- Επιλογή γλώσσας: Ελληνικά - Αγγλικά
- Υποστηρίζει FISH EYE λειτουργία 170°
- Εύκολη ρύθμιση για smart Phone ή Tablet μέσω QR Code.
- Επίτοιχη τοποθέτηση
- Ελληνικό μενού οδηγιών στη θόνη.
- Εύκολος προγραμματισμός μέσω dip-switch
- Μυστικότητα συννομίας και video,
- Ενεργοποίηση - απενεργοποίηση κλήσης



36

## Product Information

### Description

2-wire system 7.0" touch screen monitor with memory & recording and Wi-Fi connectivity.

### Features

- 7.0" TFT touch screen
- Touch screen operation
- Touch sensor button
- Call transfer to mobile phone
- Inner picture memory and SD card storage extension
- IP camera integration
- Stair light and 2nd lock control
- Intercom and inner intercom
- Doorbell and ringer connection

### Dimension

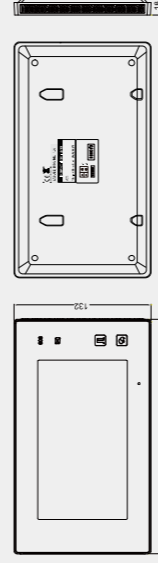

### Terminal Description

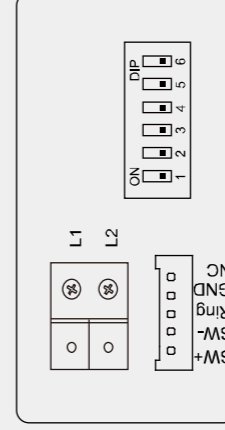

**L1,L2:** Bus line terminal.

**POW,GND:** 12~18V extra power connection port.

**Ring,GND:** Extra buzzer connection port.

**SW+,SW-:** Extra door bell connection port.

**DIP switches:** Total 6 bits can be configured.

**Bit1 ~Bit5:** User Code setting switch.

**Bit6:** Video impedance matching switch.

### Πλήκτρα αφής

Το νέο μονίτορ Θυροτηλεόρασης σας δίνει τη δυνατότητα να απαντήσετε στον επισκέπτη μέσω του Smart Phone ακόμα και αν δεν είστε στο σπίτι και είναι συμβατή με τα υπάρχοντα συστήματα της εταιρείας μας. Συνδέεται μέσω WiFi του διαμερισματος σας και μεταφέρει την κλήση (Ομιλία, εικόνα, άνοιγμα πόρτας)στο κινητό του χρήστη μέσω Δωρεάν εφαρμογής για Android & ios.

### Χαρακτηριστικά

- TFT Οθόνη αφής 7" Ιντσών
- Πλήκτρα αφής
- Αποθήκευση φωτογραφίας επισκέπτη
- Δέχεται SD card 16GB για καταγραφή video
- Επιλογή μελωδίας
- Έντασης κλήσης
- Αυτόκλιση
- Επιλογή γλώσσας: Ελληνικά - Αγγλικά
- Υποστηρίζει FISH EYE λειτουργία 170°
- Εύκολη ρύθμιση για smart Phone ή Tablet μέσω QR Code.
- Επίτοιχη τοποθέτηση
- Ελληνικό μενού οδηγιών στη οθόνη.
- Εύκολος προγραμματισμός μέσω dip-switch
- Μυστικότητα συνομιλίας και video.
- Ενεργοποίηση – απενεργοποίηση κλήσης



38

### Description

2-wire system 7" touch screen monitor touch screen memory & recording.

### Features

- Touch screen
- Ultra flat
- Touch sensor button
- Inner picture memory and SD card storage extension
- IP camera integration
- Stair light and 2nd lock control
- Intercom and inner intercom
- Doorbell and ringer connection

### Standard specifications



DT47MG/TD7-W



Optional Wi-Fi version DX47

### Dimension

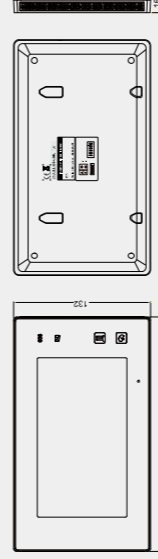

### Terminal Description

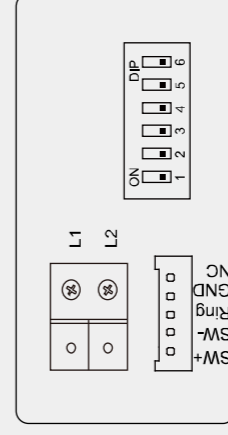

L1,L2: Non-polarity bus line.

SW+,SW-: Doorbell call button connection port.

Ring,GND: Extra buzzer connection port.

NC: Reserved.

DIP switches: Total 6 bits can be configured.

Bit1~Bit5: User Code setting switch.

Bit6: Video impedance matching switch.

## Product Information

### • Τεχνολογία 2 καλοδιδίων

Υποστηρίζει FISH EYE λειτουργία 170° Σύνδεση με το IPG για κλήση μέσω εφαρμογής smart phone ή το Tablet (κατόπιν τηλεφωνικής παραγγελιάς )

- > 7 ιντσών ψηφιακή έγχρωμη οθόνη TFT Αφής
- > Υψηλής ανάλυσης 800\*480 pixels.
- > Λεπτός σχεδιασμός με μόνο 15mm πάχος
- > Δυνατότητα Ενδοσκοπικών
- > Εύκολος χειρισμός (εικόνες με Ελληνικό μενού στην οθόνη). Δυνατότητα επιλογής γλώσσας
- > Λειτουργία μνήμης (Φωτογραφία επισκέπτη ή Βίντεο με καταγραφή συνομιλίας ).
- > Touch sensor home button
- > Συμβατό με όλη τη σειρά 2Easy SB DT

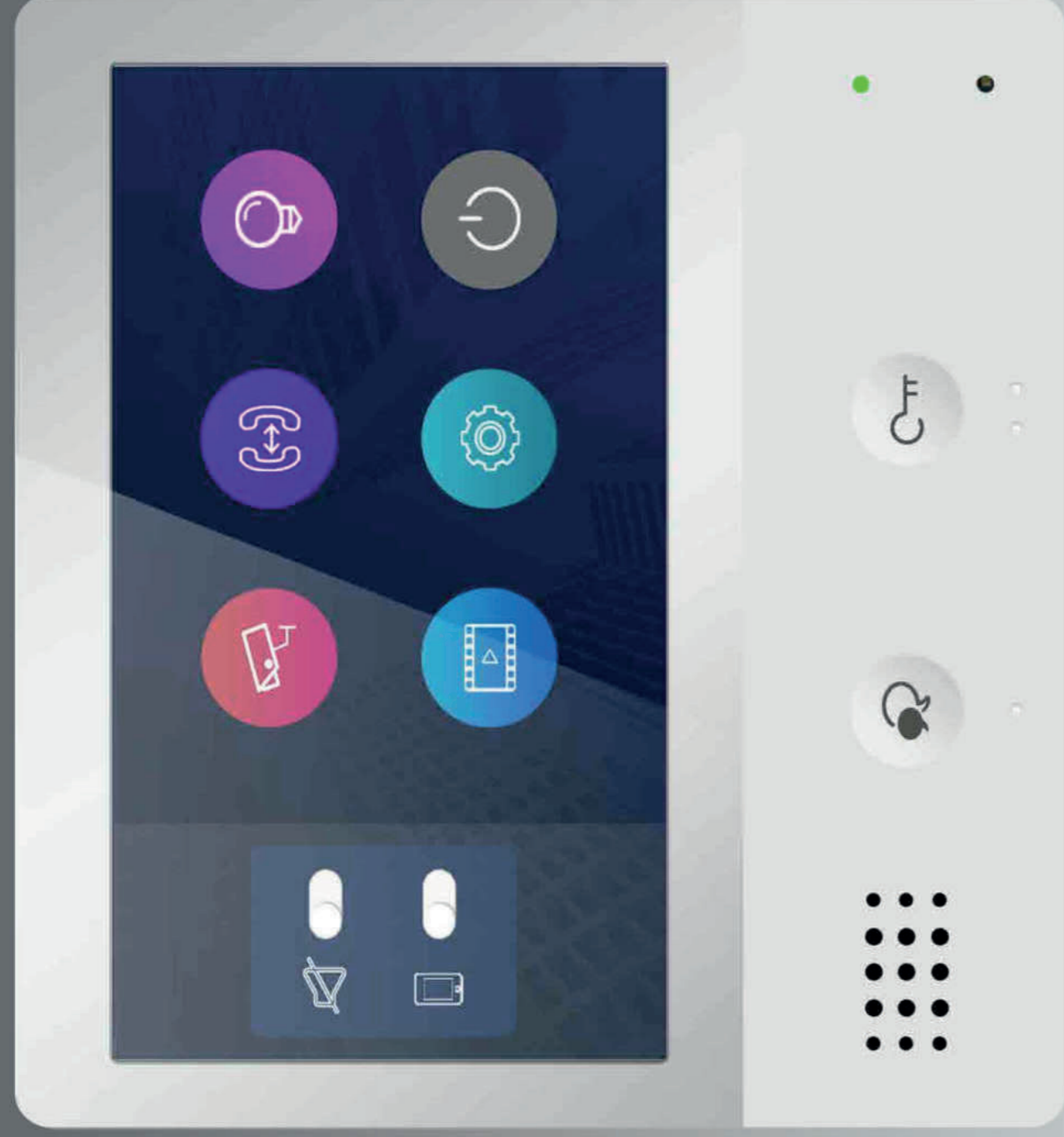

40

### Description

2-wire system 7" TFT monitor with touch screen.

### Features

- 7" TFT touch screen
- Touch screen
- Touch sensor button
- Navigation dot for disable person
- Intercom and inner intercom
- Stair light and 2nd lock control
- Doorbell and ringer connection
- Supports public memory & IPC integration & call transfer function via DT-IPG connection

### SB DT 471

- Τεχνολογία 2 καλωδίων
- 7 ιντσών ψηφιακή έγχρωμη οθόνη TFT Αφής
- Ανάλυση: 800 x 480 pixels •
- Φινίρισμα: Λευκό με ανοιχτό γκρι πλαίσιο
- Τοποθέτηση: Επίτοιχη ή επιτραπέζια με βάση γραφείου (προσθετη αγορά)
- 12 επιλογές ήχου κλήσης
- Ένταση ήχου κλήσης
- Λειτουργίες Pan, Tilt και Zoom
- Νυχτερινή Λειτουργία
- Ρολόι και ημερολόγιο
- Λειτουργία «Μην ενοχλείτε»
- Αυτόκληση
- Λειτουργία ενδοεπικοινωνίας

Διαστάσεις: W174 x H160 x D22mm

## Product Information

### Packing Information

#### Single Package



Dimensions: 165(H)×240(W)×39(D)mm  
Gross Weight: 0.55Kg

#### Carton Package



Carton: 258 (H)×530 (W)×340 (D)mm  
Quantity: 24PCS

### Dimension

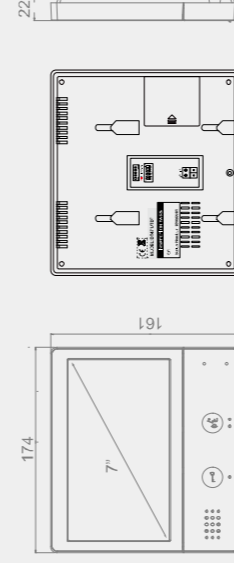

### Terminal Description

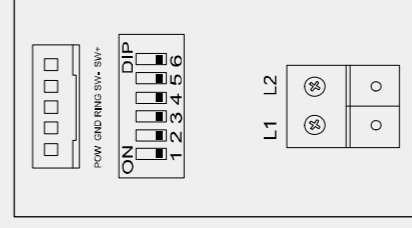

**L1, L2:** Bus line terminal.

**POW, GND:** 12~18V extra power connection port.

**Ring, GND:** Extra buzzer connection port.

**SW+, SW-:** Extra door bell connection port.

**DIP switches:** Total 6 bits can be configured.

**Bit1 ~Bit5:** User Code setting switch.

**Bit6:** Video impedance matching switch.

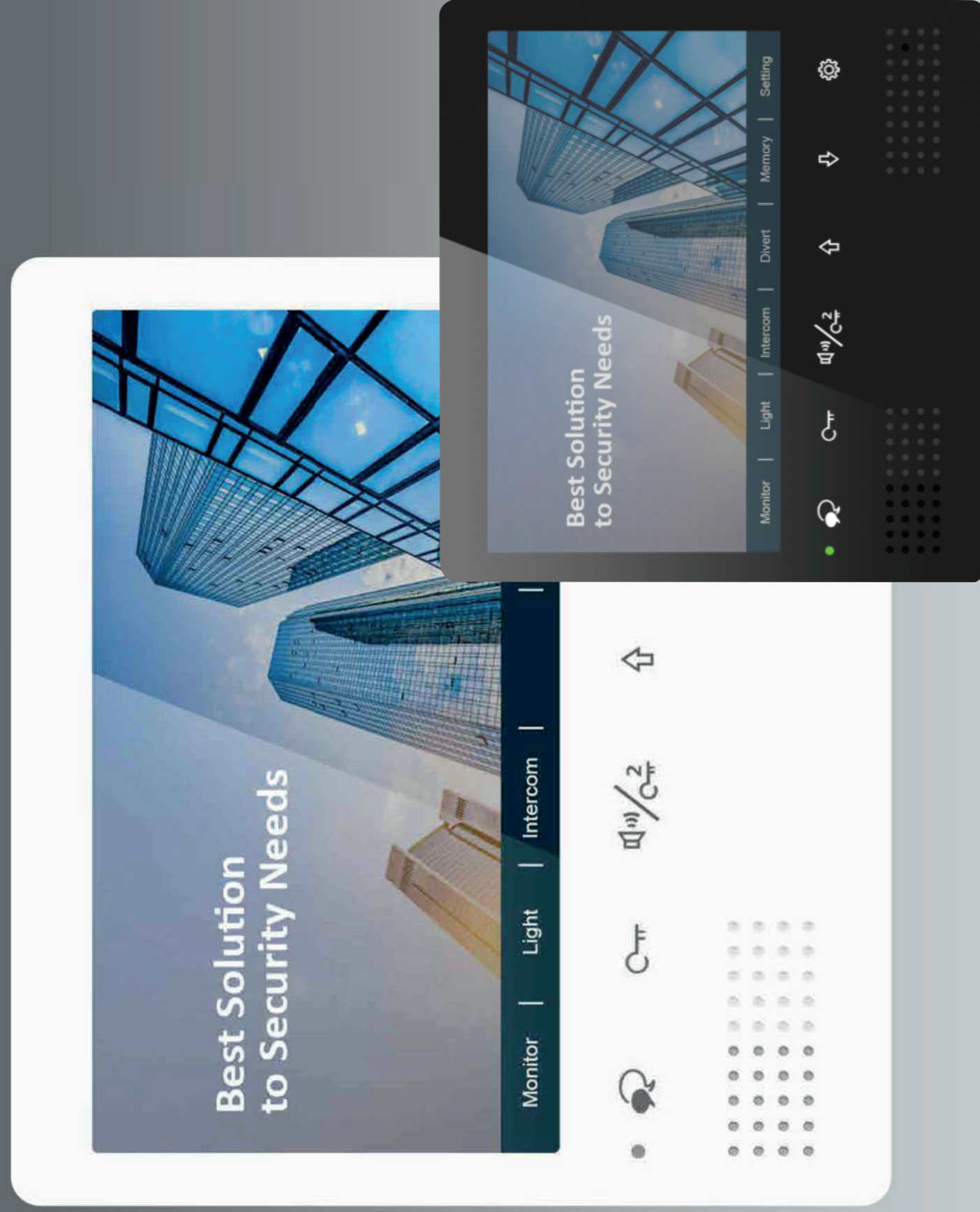

42

## Product Information

### Description

2-wire system 7" TFT monitor with touch sensor button with white/black housing.

### Features

- Touch sensor button
- Full white or black housing for choice
- Intercom and inner intercom
- Stair light and 2nd lock control
- Doorbell and ringer connection
- Supports public memory & IPC integration& call transfer function via DT-IPG connection

- 7" Έγχρωμη TFT οθόνη
- Πλήρες οθόνη
- Λεπτός σχεδιασμός.
- Εύκολος χειρισμός
- Μπλουτόν Αφής
- Δυνατότητα Ενδοεπικοινωνίας
- Ελληνικό μενού οδηγιών στην οθόνη
- Χωρίς ακουστικό (Hands Free)
- Συμβατό με όλη τη σειρά 2Easy SB DT

7"inch TFT screen

**Size:173.5\*161\*18mm**

### Dimension

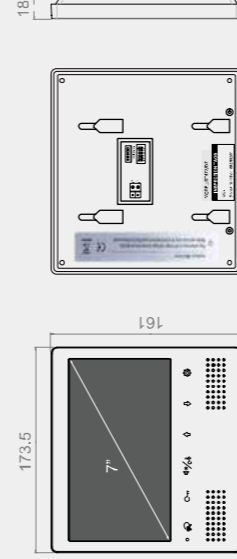

### Terminal Description

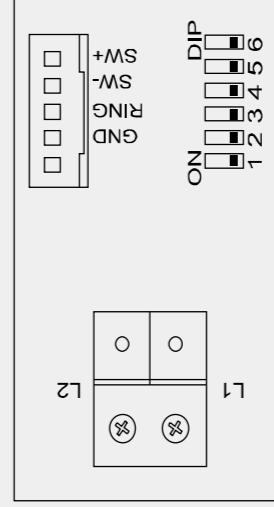

**SW+,SW-**: Extra door bell call button connection port.

**RING,GND**: Extra buzzer connection port.

**L1,L2**: Bus terminal.

**DIP switches**: Total 6 bits can be configured.

**Bit1 ~Bit5**: Used to User Code setting.

**Bit6**: Video impedance matching switch.

### Packing Information

#### Single Package



Dimensions: 165(H) $\times$ 240(W) $\times$ 39(D)mm

Gross Weight: 0.52Kg

#### Carton Package



Carton: 258 (H) $\times$ 530 (W) $\times$ 340 (D)mm

Quantity: 24PCS



44

## Product Information

### Description

2-wire system 4.3" TFT monitor with touch sensor button.

### Features

- Touch sensor button
- PMMA front panel
- Intercom and inner intercom
- Stair light and 2nd lock control
- Doorbell and ringer connection
- Multi languages menu
- Supports public memory & IPC integration and call transfer function via DT-IPG connection

- 4.3" TFT Έγχρωμη TFT οθόνη
- Πλήρες οθόνη
- Λεπτός σχεδιασμός.
- Εύκολος χειρισμός
- Δυνατότητα Ενδοεπικοινωνίας
- Ελληνικό μενού οδηγιών στην οθόνη
- Χωρίς ακουστικό (Hands Free)
- Συμβατό με όλη τη σειρά 2Easy SB DT

**Size: 137\*137\*18mm**

### Dimension

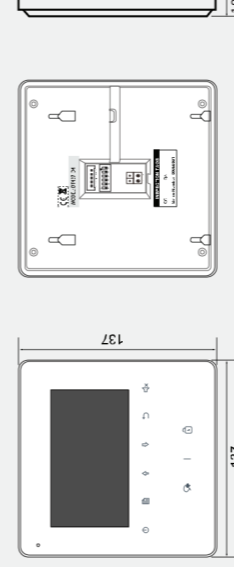

### Terminal Description

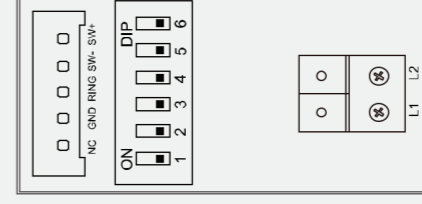

**L1,L2:** Non-polarity bus line.

**SW+,SW-:** Doorbell call button connection port.

**Ring,GND:** Extra buzzer connection port.

**NG:** Reserved.

**DIP switches:** Total 6 bits can be configured.

**Bit1 ~Bit5:** User Code setting switch.

**Bit6:** Video impedance matching switch.

### Packing Information

#### Single Package



Dimensions: 155(H) $\times$ 142(W) $\times$ 28(D)mm

Gross Weight: 0.29Kg

#### Carton Package



Carton: 325 (H) $\times$ 298 (W) $\times$ 380 (D)mm

Quantity: 48PCS

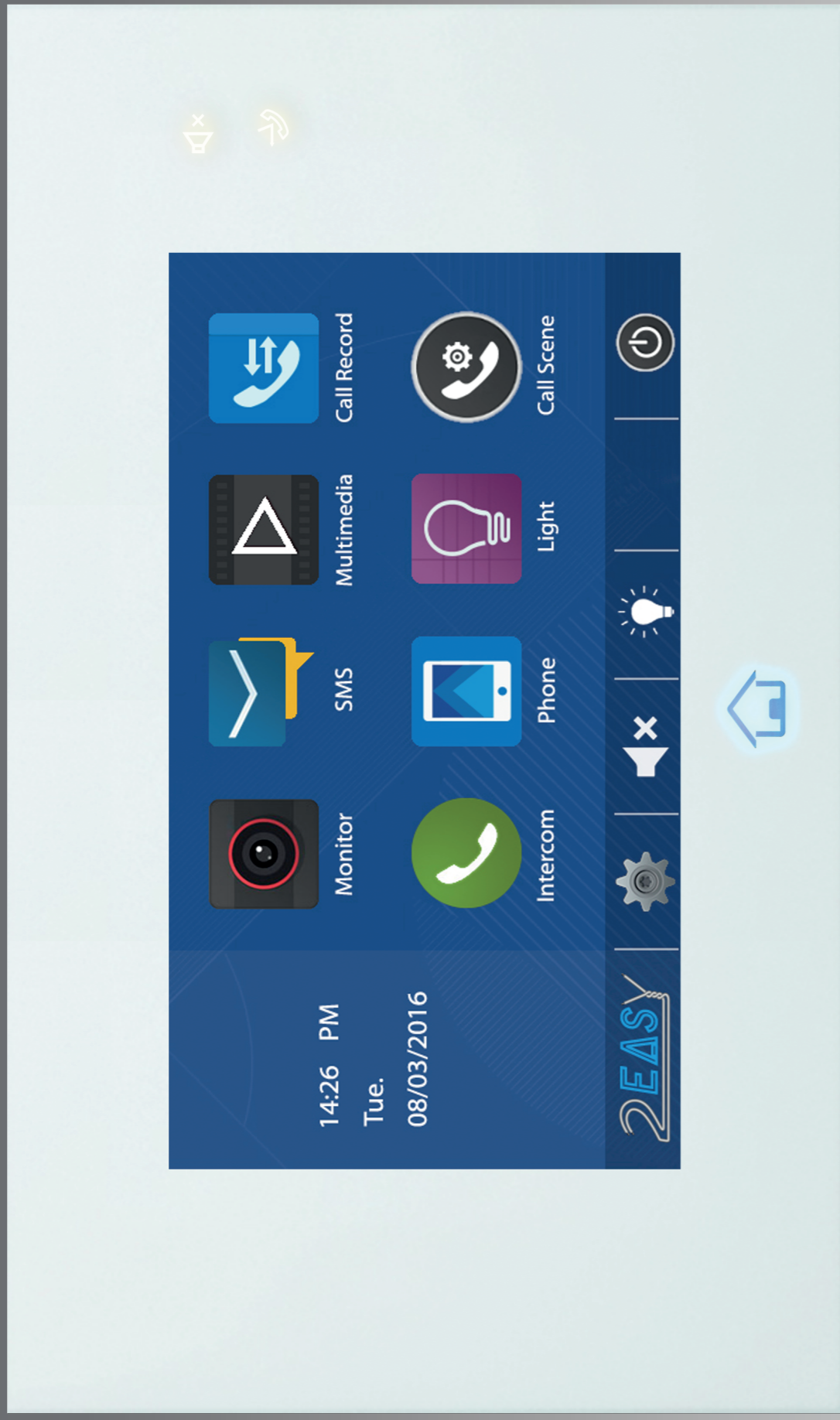

#### Προστασία οθόνης από κρύσταλλο ασφαλείας

- 7 ιντσών Ψηφιακή έγχρωμη οθόνη TFT Αφής
- Υψηλής ανάλυσης 800\*480 pixels.
- Λειτουργία μνήμης (Φωτογραφία επισκέπτη ή Βίντεο με καταγραφή συνομιλίας).
- Λεπτός σχεδιασμός
- Δυνατότητα Ενδοεπικοινωνίας
- Εύκολος χειρισμός (εικόνες με Ελληνικό μενού στην οθόνη).
- Πολύγλωσσο μενού ( Ελληνικά, Αγγλικά, Ισπανικά Γερμανικά και πολλές άλλες γλώσσες )

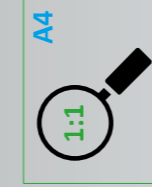

46

- Δυνατότητα επιλογής γλώσσας
- Δυνατότητα δημιουργίας λίστας ονομάτων για την ενδοεπικοινωνία

**Dimension: 139(H)×234(W)×19(D)mm**



#### Χαρακτηριστικά

- TFT Οθόνη αφής 7" Ιντσών
- Πλήκτρα αφής
- Αποθήκευση φωτογραφίας επισκέπτη
- Δέχεται SD card 16GB για καταγραφή video
- Επιλογή μελωδίας
- Έντασης κλήσης
- Αυτόκληση
- Επιλογή γλώσσας: Ελληνικά - Αγγλικά
- Υποστηρίζει FISH EYE λειτουργία 170
- Εύκολη ρύθμιση για smart Phone ή Tablet μέσω QR Code.
- Επίτοιχη τοποθέτηση
- Ελληνικό μενού οδηγίων στη οθόνη.
- Εύκολος προγραμματισμός μέσω dip-switch
- Μυστικότητα συνομιλίας και video.
- Ενεργοποίηση - απενεργοποίηση κλήσης



#### Πλήκτρα αφής

Το νέο μονίτορ Θυροτηλεόρασης σας δίνει τη δυνατότητα να απαντήσετε στον επισκέπτη μέσω του Smart Phone ακόμα και αν δεν είστε στο σπίτι και είναι συμβατή με τα υπάρχοντα συστήματα της εταιρείας μας. Συνδέεται μέσω WiFi του διαμερίσματος σας και μεταφέρει την κλήση (Ομιλία, εικόνα, άνοιγμα πόρτας) στο κινητό του χρήστη μέσω Δωρεάν εφαρμογής για Android & ios.



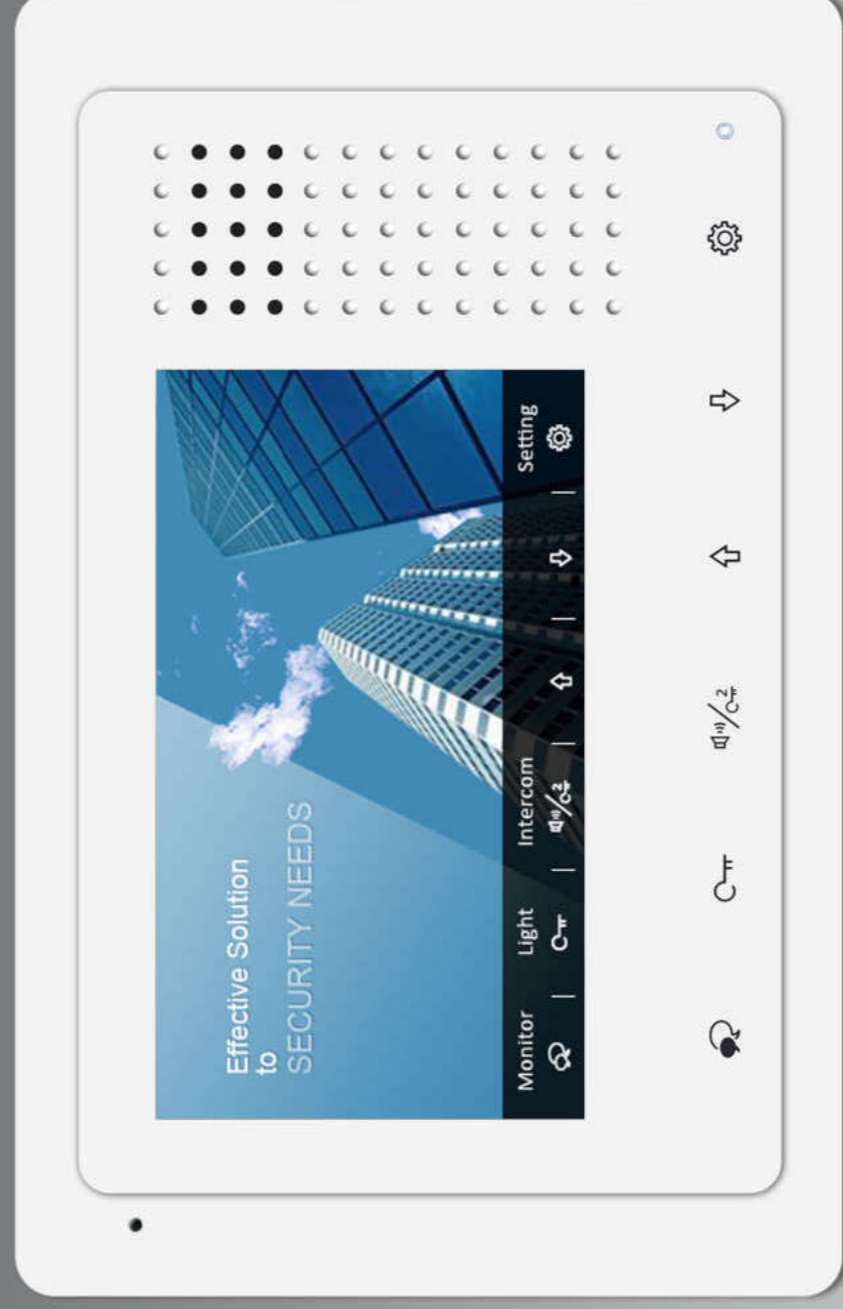

48

## Product Information

### Description

2-wire system 4.3" TFT monitor with touch sensor button

### Features

- Touch sensor button
- Slim design w/o no bracket
- Intercom and inner intercom
- Stair light and 2nd lock control
- Doorbell and ringer connection
- Supports public memory & IPC integration & call transfer function via DT-IPG connection

### Dimension

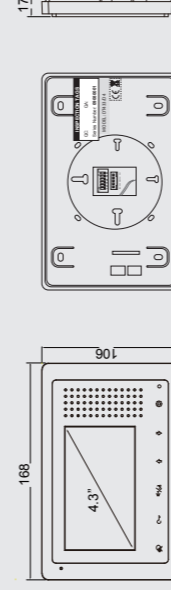

### Terminal Description

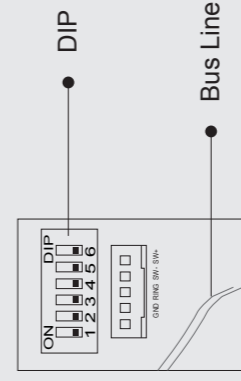

**Bus Line:** BUS line terminal.

**SW+,SW-:** Doorbell call button connection port.

**Ring,GND:** Extra buzzer connection port.

**DIP:** Total 6 bits can be configured.

**Bit1 ~Bit5:** Used to User Code setting.

**Bit6:** Set to ON if the monitor is at the end of the line or works with DBC4A. Otherwise, set to OFF.

**L1,L2:** Non-polarity bus line.

**SW+,SW-:** Doorbell call button connection port.

**Ring,GND:** Extra buzzer connection port.

**NG:** Reserved.

**DIP switches:** Total 6 bits can be configured.

**Bit1 ~Bit5:** User Code setting switch.

**Bit6:** Video impedance matching switch.

- 4,3 " Έγχρωμη TFT οθόνη
- Πλήρες οθόνη
- Λεπτός σχεδιασμός. 17 mm
- Εύκολος χειρισμός
- Μπουτόν Αφής
- Δυνατότητα Ενδοεπικοινωνίας
- Ελληνικό μενού οδηγιών στην οθόνη
- Χωρίς ακουστικό (Hands Free)
- Συμβατό με όλη τη σειρά 2Easy SB DT

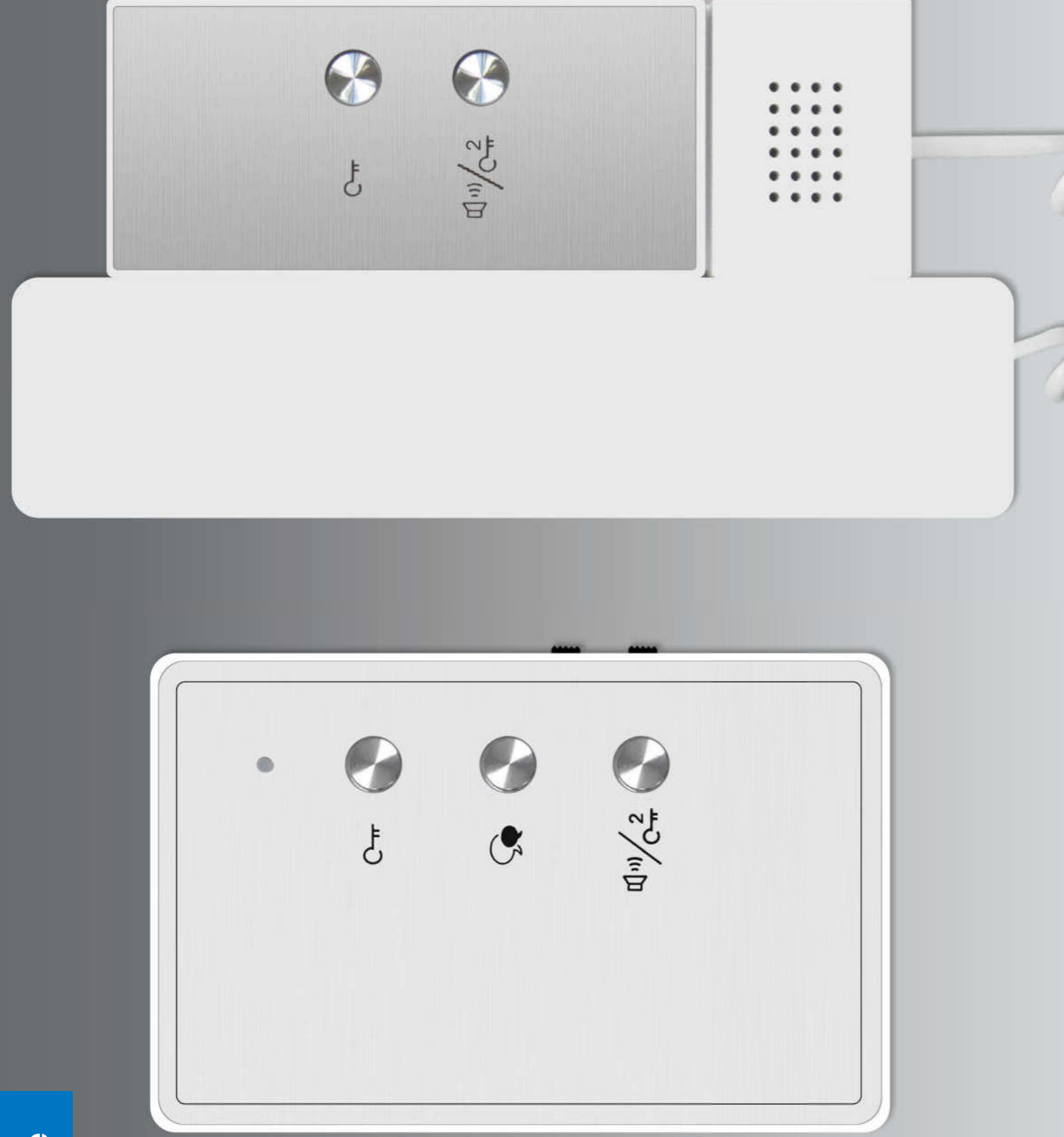

50

## Description

[DJ7A] Hand free audio phone  
[DJ4A] Handset audio phone

## Features

- Hand free or Handset
- Aluminum front panel
- Inner intercom with family members
- Support 2nd lock control via relay actuator
- Doorbell and ringer connection

## Dimension

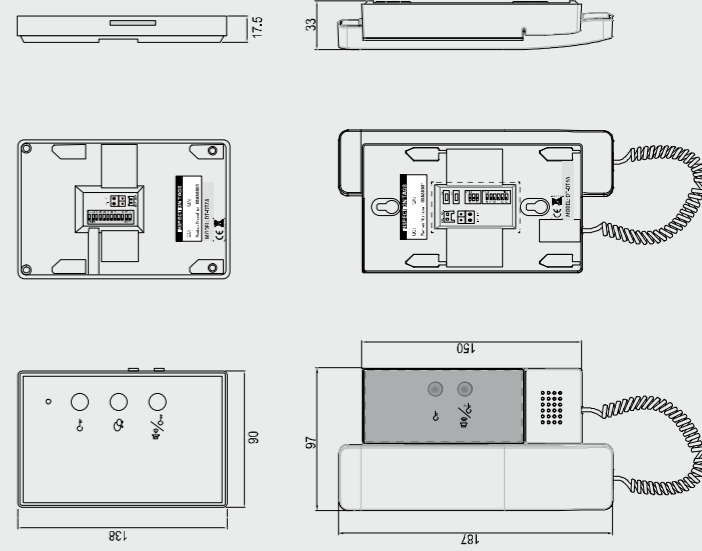

## Terminal Description

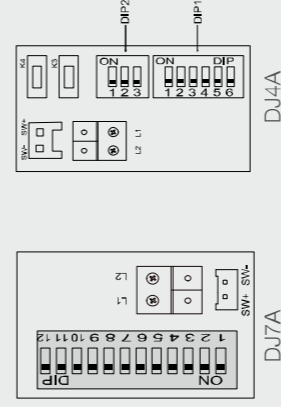

**L1, L2:** BUS line terminal.

**SW+, SW-:** Door bell call button connection port.

### DIP:

**Bit-1 ~7:** Used to User Code setting or Extended Address setting(Bit-10 set to ON).

**Bit-8~9:** Used to Slave Monitor Address (Bit-10 set to OFF).

**Bit-11:** Set to ON if the monitor is at the end of the line,Otherwise, set to OFF.

**Bit-12:** Reserved.

**SW+,SW-:**Door bell call button connection port.

**L1,L2:**Bus terminal.

**K4:**Used to Ring Tone setting.

**K3:**Used to Ring Volume setting.

**DIP1** (Bit1 ~6):Used to User Code setting.

**DIP2**(Bit1 ~3):Used to Slave Monitor Address or Extended Address setting.

- Συσκευή θυροτηλεφώνου ανοιχτής ακρόασης με ακουστικό
- Νέα βελτιωμένη συσκευή με μεγαλύτερη ένταση κλήσης (από το SB DJ7A Version 1)
- 2 πλήκτρα για άνοιγμα 2 κυπρί

## Product Information

### Packing Information

#### Single Package



Dimensions: [DJ7A]95(H)x23(W)x15(D)mm  
[DJ4A]98(H)x60(W)x200(D)mm

Gross Weight: [DJ7A]0.40Kg  
[DJ4A]0.40Kg

#### Carton Package



Carton: [DJ7A]298(H)x380(W)x325(D)mm  
[DJ4A]415(H)x360(W)x265(D)mm

Quantity: [DJ7A]96PCS  
[DJ4A]28PCS

# Ordering list of Villa outdoor station

## • DT610



Product code	Model No.	Description	Qty of package
P23991001	DT610	Single family villa door station with fisheye camera	32 pcs
P23991002	DT610C	Single family villa door station with 105 degree view angle	32 pcs

## • DT611-MK



Product code	Model No.	Description	Qty of package
P23996211	DT611/MK	Single family villa door station with fisheye camera and mechanical keypad access	28 pcs
P23996253	DT611C/MK	Single family villa door station with mechanical keypad access and 105 degree view angle	28 pcs



P23996217	DT611F/MK	Single family villa door station with fisheye camera and mechanical keypad access	15 pcs
P23996255	DT611CF/MK	Single family villa door station with mechanical keypad access and 105 degree view angle	15 pcs

## • DT611-KP



Product code	Model No.	Description	Qty of package
P23996210	DT611/KP	Single family villa door station with fisheye camera and touch key access	28 pcs
P23996252	DT611C/KP	Single family villa door station with touch key access and 105 degree view angle	28 pcs



P23996217	DT611F/KP	Single family villa door station with fisheye camera and touch key access	15 pcs
P23996255	DT611CF/KP	Single family villa door station with touch key access and 105 degree view angle	15 pcs

## • DT607C



Product code	Model No.	Description	Qty of package
P23997009	DT607C-S1	Single family villa door station with 105 degree view angle	28 pcs
P23997010	DT607C-S2	Two push buttons villa door station with 105 degree view angle	28 pcs

## • DT607ID/FE



Product code	Model No.	Description	Qty of package
P23997005	DT607ID/FE-S1	Single family villa door station with fisheye camera and proximity access	28 pcs
P23997004	DT607ID/FE-S2	Two push buttons villa door station with fisheye camera and proximity access	28 pcs



P23997003	DT607ID/FE-S3	Three push buttons villa door station with fisheye camera and proximity access	28 pcs
P23997002	DT607ID/FE-S4	Four push buttons villa door station with fisheye camera and proximity access	28 pcs

## • DT607F/ID/FE



Product code	Model No.	Description	Qty of package
P23997013	DT607F/ID/FE-S1	Single family villa door station with fisheye camera and proximity access	15 pcs
P23997012	DT607F/ID/FE-S2	Two push buttons villa door station with fisheye camera and proximity access	15 pcs



P23997011	DT607F/ID/FE-S3	Three push buttons villa door station with fisheye camera and proximity access	15 pcs
P23997010	DT607F/ID/FE-S4	Four push buttons villa door station with fisheye camera and proximity access	15 pcs

# Ordering list of Assembled apartment outdoor station

## NOTES

.....

.....

.....

.....

.....

.....

.....

### • DT821



Product code	Model No.	Description	Qty of package
P31219401	DT821/BS4-F	4 push buttons apartment door station with blind module 821 module list: VD & BL & S4 & 3X1F	7 pcs
P31219402	DT821/DK-F	Single family villa door station with touch key access 821 module list: VD & DR & MK & 3X1F	7 pcs

### • DT608



Product code	Model No.	Description	Qty of package
P23998001	DT608/ID/FE-S8	Push button apartment door station with big nameplate	12 pcs
P23998003	EP608-S12	Push button extended panel with big nameplate	12 pcs

### • DMR21



Product code	Model No.	Description	Qty of package
P31219003	DMR21/ID/S4	4 push buttons apartment door station with proximity access	7 pcs

### • DMR21-F1



Product code	Model No.	Description	Qty of package
P31219010	DMR21/S4/F1	4 push buttons apartment door station with blank	7 pcs

### • EP21 & R21/F1



Product code	Model No.	Description	Qty of package
P31219009	EP21/S12	12 push buttons extended panel for DMR21	7 pcs
P31219041	R21/ID	ID card reader module for empty F1 of DMR21	68 pcs
P31219043	R21/TFT	3.5" TFT module for empty F1 of DMR21	68 pcs
P31219040	R21/LB	Info module for empty F1 of DMR21	68 pcs

# Ordering list of 821 modularized outdoor station

## • 821 Controller

	Product code	Model No.	Description	Qty of package
	P31219406	821/VD	Video controller module with fisheye lens	54 pcs
	P31219407	821/AD	Audio controller module	54 pcs

## • 821 Direct call button

	Product code	Model No.	Description	Qty of package
	P31219537	821/M4	4 users physical call button module	54 pcs
	P31219403	821/S4	4 users touch call button module	54 pcs

## • 821 Digital call and display

	Product code	Model No.	Description	Qty of package
	P31219405	821/DR	Proximity unlock and Dot-matrix display module	54 pcs
	P31219404	821/MK	Digital keypad module for code unlock & room number calling	54 pcs
	P31219611	821/T5	5" Touch screen module for display & room number calling & code unlock & proximity unlock	15 pcs

## • 821 others

	Product code	Model No.	Description	Qty of package
	P31219541	821/FP	Capative fingerprint module for unlock	54 pcs
	P31219410	821/LB	Lable information module	54 pcs
	P31219408	821/TFT	3.5" TFT display module	54 pcs
	P31219411	821/BL	Blind module Blind panel for single empty	54 pcs
	P91010331	821/S0	Blind module for single empty button	

## • 821 2X1 Frame and Rainy cover

	Product code	Model No.	Description	Qty of package
	P31219418	821S-2X1	2-module surface mounting rainy cover box with front panel	8 pcs
	P31219414	821F-2X1	2-module front frame with flush mounting box	8 pcs

## • 821 2X2 Frame and Rainy cover

	Product code	Model No.	Description	Qty of package
	P31219419	821S-2X2	4-module surface mounting rainy cover box with front panel	5 pcs
	P31219415	821F-2X2	4-module front panel with flush mounting box	5 pcs

## • 821 3X1 Frame and Rainy cover





	Product code	Model No.	Description	Qty of package
	P31219416	821S-3X1	3-module surface mounting rainy cover box with front panel	7 pcs
	P31219412	821F-3X1	3-module front frame with flush mounting box	7 pcs

## • 821 3X2 Frame and Rainy cover

	Product code	Model No.	Description	Qty of package
	P31219417	821S-3X2	6-module surface mounting rainy cover box with front panel	5 pcs
	P31219413	821F-3X2	6-module front frame with flush mounting box	5 pcs

# Ordering list of Indoor station





## • Standard monitor

	Product code	Model No.	Description	Qty of package
	P40 P29470300	DT471/TD7	7" TFT monitor with touch screen	24 pcs
	P29470314	DT471-HS	7" TFT monitor with touch screen and handset	10 pcs
	P42 P29470512	DT472/D7/W	7" TFT monitor with touch sensor button	24 pcs
	P44 DT436/D4	DT436/D4	4.3" TFT monitor with touch sensor button	48 pcs



## • Basic monitor

	Product code	Model No.	Description	Qty of package
	P48 P29432006	DT433/D4	4.3" TFT monitor with touch sensor button	64 pcs

## • Wi-Fi monitor and memory monitor





	Product code	Model No.	Description	Qty of package
	P36 P29439001	DX439/TD4	4.3" touch screen monitor with memory & recording and Wi-Fi connectivity	24 pcs
	P34 P29471001	DX471/TD7	7" touch screen monitor with memory & recording and Wi-Fi connectivity	24 pcs
	P29470101	DX47/TD7-W	7" touch screen monitor with memory & recording and Wi-Fi connectivity	24 pcs
	P38 P29470066	DT47MG/TD7-W	7" touch screen monitor touch screen memory & recording	24 pcs

## • Audio phone





	Product code	Model No.	Description	Qty of package
	P50 P24907002	DT-DJ7A	Handset phone	96 pcs
	P50 P24904006	DT-DJ4A	Handfree phone	28 pcs

# Ordering list of Accessory





## • Power supply unit

	Product code	Model No.	Description	Qty of package	Specification
	P34092202	PC7H	Power combo	32 pcs	24VDC 2.5A output Power supply and Power seperator 5 din rail
	P34092201	PC7	Power combo	54 pcs	24VDC 1.5A output Power supply and Power seperator 4 din rail
	P34096101	DPS(V2)	New power seperator (Version 2)	54 pcs	Power seperator Should work together with power unit 2 din rail
	P34094001	PC4	Power combo	60 pcs	24V DC 0.75A outputs Use in basic villa kit only 4 din rail
	SB LRS-100-24		Power		24VDC 4.5A output





## • Amplifier and Gateway

	Product code	Model No.	Description	Qty of package	Specification
	P23991001	BDU	Bus amplifier file	56 pcs	Repeater mode for video amplifier 4 din rail
	P23991002	IPG	IP Gateway	56 pcs	Multifunctional module Public memory, call diverting, IP camera, interface 4 din rail
	P33044001	IP-G24	Guard unit	16 pcs	4.3 inch guard unit Handset and handfree working mode
	P69010052	IPC	IP camera	10 pcs	ONVIF protocol, 1/2.9" SONY, PoE power supply, IP66 179(W) x 94(H) x 93(D)mm

## • Distributor and Relay Control

	Product code	Model No.	Description	Qty of package	Specification
	P36009057	DBC2S	Branch distributor with 2 channels	300 pcs	2 channels used for multi outdoor stations or indoor monitors 46*46mm
	P36009082	DBC4A1	Branch distributor with 4 channels	60 pcs	4 channels for multi outdoor stations or indoor monitors Isolated in each channel 4 din rail
	P36009108	DBC4R	Branch rise distributor	60 pcs	Rise line distribution 4 channels, max.8 monitors per output General isolation 4 din rail
	P36007001	RLC	Relay controller	60 pcs	10A relay 2nd lock control or light control 12V DC output 4 din rail
	P36007086	Mini-RLC	Mini relay controller	300 pcs	6A relay 2nd lock control or light control 46*46mm

## • Others

	Product code	Model No.	Description	Qty of package	Specification
	P24904301	DJ401	Handset	28 pcs	A peripheral handset Should work with dedicated monitor Connection bracket not included
	P35001039	DB1-W	White desktop brakcet	22 pcs	Desktop bracket for monitor White housing
	P35001040	DB1-B	Black desktop brakcet	22 pcs	Desktop bracket for monitor Black housing
	P69810015	TAG1	Blue tag key		EM card Used for 12kHz reader





# Sambo Hellas

ΑΦΟΙ Π. ΓΟΓΑΛΗ



Γρουπάρη 56 - Καλλιθέα  
Τηλ: 210 9512191, 210 95 88732 - Fax: 210 9588732  
e-mail: info@sambo.gr



[www.sambo.gr](http://www.sambo.gr)